

Description

Pedestrian gate mWing

MHTM™ FlowMotion®

Control unit MGCplus

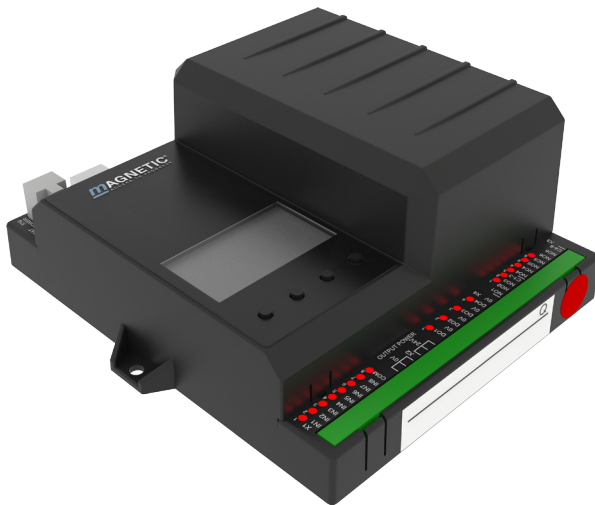

Control unit MGCplus

MAGNETIC AUTOCONTROL GMBH

Grienmatt 20
D-79650 Schopfheim
Germany

Phone +49 7622 695 5
Fax +49 7622 695 802
info@magnetic-germany.com
www.magnetic-access.com

Contents

1	Notices on the document	7
1.1	Purpose and contents of this description	7
1.2	Symbols and illustrations used in this document	8
1.2.1	Warning notes and notes	8
1.2.2	Abbreviations used	9
1.3	Target group	10
1.3.1	Personnel – activities and qualifications	10
2	Definitions	11
2.1	General Definitions	11
2.2	Unauthorised access attempts	12
3	Operation modes	13
3.1	Description	13
3.2	Setting the Open mode via control unit	15
3.3	Special operating modes	16
3.4	Control of the passages with "Control direction 1" and/or "Control direction 2"	17
3.4.1	Explanations	17
3.4.2	Parameter "Control variant" – Option "Variant 1"	19
3.4.3	Parameter "Control variant" – Option "Variant 2"	21
4	Digital inputs, digital outputs and relay outputs	23
4.1	Digital inputs	23
4.2	Digital outputs and relay outputs	26
5	Parameterising control unit	29
5.1	Changing menu language	29
5.2	Entering password	33
5.3	Control unit elements	34
5.4	Displays of the control unit	35
5.5	Symbols in the display	36
5.5.1	Control button functions	36
5.5.2	Further symbols	37
5.6	Setting display contrast	38

Contents

5.7	Protecting parameterisation from access	38
5.8	Parameterise value	38
5.9	Switching the "Service" mode on and off	39
<hr/>		
6	Description of menus and parameters	40
6.1	Menu "Information"	40
6.2	Menu "Settings"	41
6.2.1	Operating mode	41
6.2.2	Validations	42
6.2.3	Speed Wings	44
6.2.4	Safety	45
6.2.4.1	General	45
6.2.4.2	Low energy	47
6.2.4.3	Intrusion	48
6.2.4.4	Wrong direction	49
6.2.4.5	Tailgating	50
6.2.5	Safety	51
6.2.5.1	Forced opening	51
6.2.5.2	Lock wings autom.	51
6.2.5.3	Warning light barriers (PE beams)	52
6.2.6	Signalling	52
6.2.6.1	Buzzer	52
6.2.6.2	GED no. 1 / GED no. 2	53
6.2.7	Random check function	56
6.2.8	Home offset	58
6.3	Menu "Inputs/Outputs"	59
6.3.1	Digital inputs 1-8	59
6.3.2	Digital outputs 1-4 and relay outputs 1-6	59
6.4	Menu "Information"	59
6.4.1	Operating mode	59
6.4.2	People Counter	59
6.4.2.1	In direction 1	59
6.4.2.2	In direction 2	60
6.4.3	Light barriers (PE beams)	60
6.5	Menu "System"	61
6.5.1	Restore settings	62
6.6	Menu "Service"	62

7	Corrective action	64
7.1	Safety in troubleshooting	64
7.2	Malfunctions pedestrian gate	65
7.3	Event, warning and error messages in the display	66
7.3.1	Event, warning and error messages – Logic control (Control unit)	67
7.4	Perform reset	69
8	Menu setup	70
Index		77

1 Notices on the document

1.1 Purpose and contents of this description

This document describes the MGCplus control unit for the firmware versions listed below.

The firmware number (Firmware #), the firmware name and the firmware version (FW Version) are displayed in the "Firmware" menu (System > Control unit > Firmware).

Firmware ID	Version
49160013 (mWing)	1.0.0

Table 1: MGCplus control unit firmware version



IMPORTANT!

For information on design and function, for technical data, installation and assembly, electrical connection, commissioning and cleaning and maintenance, see the separate operating instructions "Pedestrian gate MHTM™ FlowMotion® mWing (Doc.ID: 5817,0034)".



1.2 Symbols and illustrations used in this document



1.2.1 Warning notes and notes

Warning notes are characterised by pictograms in these operating instructions. A warning note starts with a signal word that expresses the extent of the hazard.

It is absolutely essential to observe the warning notes and to proceed with caution in order to prevent accidents as well as bodily injuries and property damage.

Warning Notes

 DANGER	
	The signal word DANGER points to an immediately dangerous situation, which leads to death or severe injuries if it is not avoided.

 WARNING	
	The signal word WARNING points to a potentially dangerous situation, which can lead to death or severe injuries if it is not avoided.

 CAUTION	
	The signal word CAUTION points to a potentially dangerous situation, which can lead to minor injuries if it is not avoided.

NOTICE	
	The signal word NOTICE points to a potentially harmful situation, which leads to property damage if it is not avoided.

Notes and recommendations



IMPORTANT!

The signal word IMPORTANT highlights useful notes and recommendations as well as information for an efficient and trouble-free operation.

1.2.2 Abbreviations used

Abbreviation	Description
Contr.	Controlled
OM	Open mode
D1	Direction 1 (passage direction 1)
D2	Direction 2 (passage direction 2)
React.	Reaction
Val.	Validated or Validation
Val. pers.	Validated person
Val. pers. passed	Validated person passed
Delay	Delay

Table 2: Abbreviations

Notices on the document

1.3 Target group

1.3.1 Personnel – activities and qualifications

All work on the control unit may only be carried out by technicians and Magnetic MHTM™ FlowMotion® service experts with the following qualifications.

Designation	Qualification
Technician	<ul style="list-style-type: none">› Has completed training as a plant mechanic, plant fitter, assembly mechanic, assembly fitter or has a comparable technical education.› Has completed training as an electrical safety expert.› Has additional knowledge and experience.› Knows the associated technical terms and regulations.› Can assess the work assigned to her/him, recognises possible dangers and take suitable safety measures.
Magnetic MHTM™ FlowMotion® service expert	<ul style="list-style-type: none">› Meets all requirements of the technician.› Trained and authorised by Magnetic.

Table 3: Qualification of the personnel – MGCplus control unit

2 Definitions

2.1 General Definitions

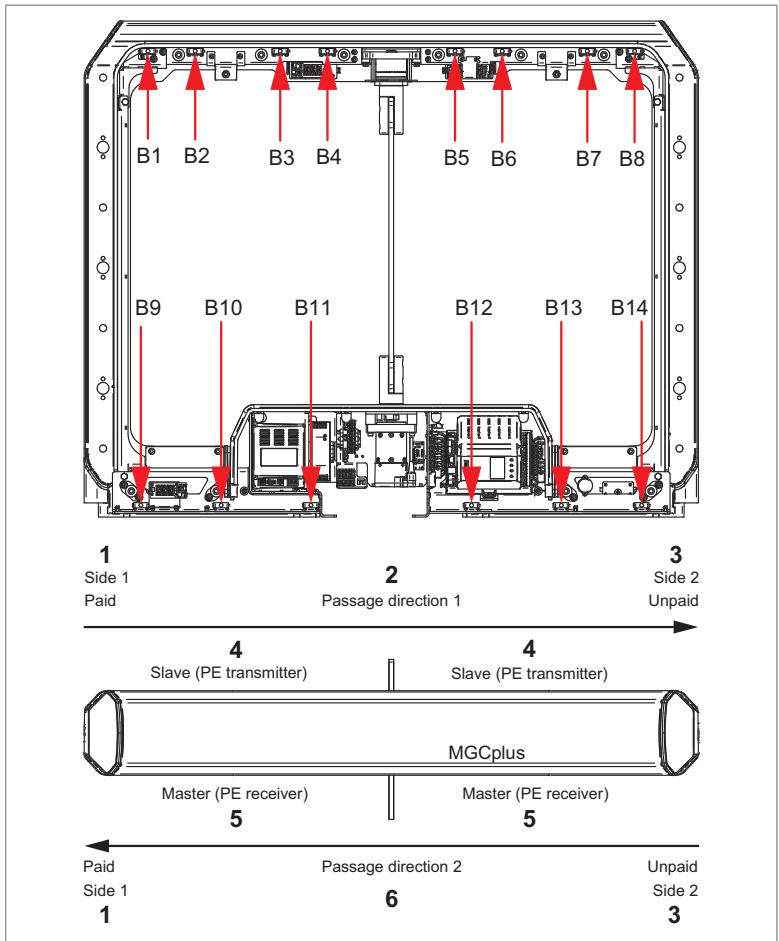

Fig. 1: Position of the light barriers (PE beams) and definitions, shown here is C-module (see following page for descriptions)

- 1 Side 1, "Paid" zone
- 2 Passage direction 1
- 3 Side 2, "Unpaid" zone
- 4 Slave, the transmitters of the light barriers (PE beams) are installed on this side
- 5 Master, the receivers of the light barriers (PE beams) are installed on this side
- 6 Passage direction 2

Definitions

Designation	Description
B1 to B14	Positioning of the light barriers (PE beams) 1 to 14. ↗ Page 11, Fig. 1.
Side 1	The "Side 1" corresponds to the "Paid" zone or the zone controlled (protected area).
Side 2	The "Side 2" corresponds to the "Unpaid" zone or the zone not controlled (unprotected area).
Passage direction 1	The "Passage direction 1" corresponds to the passage direction from the "Paid" zone to the "Unpaid" zone.
Passage direction 2	The "Passage direction 2" corresponds to the passage direction from the "Unpaid" zone to the "Paid" zone.

Table 4: Definitions

2.2 Unauthorised access attempts

The control unit differentiates between different kinds of unauthorised access attempts.

Designation	Description
Intrusion	A person without validation enters the pedestrian gate.
Tailgating	A person without validation attempts to follow a validated person.
Wrong direction	An already validated person passes the pedestrian gate in direction 1, while a second person tries to enter in direction 2. or An already validated person passes the pedestrian gate in direction 2, while a second person tries to enter in direction 1.

Table 5: Descriptions for "Unauthorised access attempts"

3 Operation modes

3.1 Description

The pedestrian gate is equipped with various operating modes.

You can force the various operating modes as follows:

- › Set the input with the corresponding function. For example, if you select the "Contr. D1/Closed D2" input, this operating mode is activated. ↗ Page 23, chapter 4.1.
- › Control the behaviour of the pedestrian gate using the input functions "Control direction 1", "Control direction 2" and "Control open mode". The "Control variant " parameter must be parameterized to match the application case. ↗ Page 17, chapter 3.4 and ↗ Page 41, "Control variant".

Input functions that force a certain operating mode have a higher priority than the input functions "Control direction 1" and "Control direction 2".

The input function | Emergency open or emergency open have the highest priority.

Operating mode	Description
No access	The pedestrian gate is closed. No validations are accepted in any direction. No passage is possible. If a person enters the pedestrian gate, the control unit interprets this as an unauthorised access attempt.
Contr. D1/Closed D2	Controlled direction 1 / Closed direction 2 The control unit only accepts validations in direction 1. Thus only passages in direction 1 are possible. In direction 2 the pedestrian gate is closed.
Closed D1/Contr. D2	Closed D1/Controlled D2 In direction 1 the pedestrian gate is closed. The control unit only accepts validations in direction 2. Thus only passages in direction 2 are possible.
Contr. D1+D2	Controlled direction 1 and direction 2 The control unit accepts validations in both directions. The validations are processed in the order in which they are received. For example, if a validation is processed in direction 1, a passage in direction 2 is not allowed.
Free D1/Closed D2	Free direction 1 / Closed direction 2 No validation is required for passages in direction 1. All persons can freely pass through the pedestrian gate in direction 1. In direction 2 the pedestrian gate is closed.

Operation modes

Operating mode	Description
Closed D1/Free D2	<p>Closed direction 1 / Free direction 2</p> <p>In direction 1 the pedestrian gate is closed.</p> <p>No validation is required for passages in direction 2. All persons can freely pass through the pedestrian gate in direction 2.</p>
Contr. D1/Free D2	<p>Validation is required for passages in direction 1.</p> <p>No validation is required for passages in direction 2.</p> <p>If a person is currently passing through the pedestrian gate in direction 2, this person must have left the pedestrian gate in direction 2. Only then can a validation in direction 1 be processed.</p> <p>If several validations in direction 1 are pending, they are processed either by a passage in direction 1 or by expiration per validation of the hold-open time. Only then can a person pass the pedestrian gate in direction 2.</p>
Free D1/Contr. D2	<p>Free direction 1 / Controlled direction 2</p> <p>See description "Contr. D1/Free D2" but in reverse.</p>
Free D1+D2	<p>Free direction 1 and direction 2</p> <p>No validation is required for passages in both directions. Simultaneously, only passage in one direction is possible.</p> <p>For example, if a person received the access authorisation in direction 1, a passage in direction 2 is not allowed. If a person enters the pedestrian gate in direction 2, the control unit interprets this as an unauthorized access attempt of the "Wrong direction" type.</p>
OM (Open mode)	<p>All operating modes, except the "No access" operating mode, also exist in the open mode variant. The addition "OM" in a designation indicates the open mode variant.</p> <p>The functionality is almost identical. The only difference is that the wings basically remain open. The wings are only closed in the event of an unauthorised access attempt.</p>

Table 6: Operating modes

3.2 Setting the Open mode via control unit

You have the following options to set the open mode for an operating mode:

- › Set the input with the corresponding function as in e.g. "Contr. D1/Closed D2 OM".
- › Additionally set the input with the function "Control open mode". The input functions are only effective in the following cases: The function "Control direction 1" is assigned to an input or the function "Control direction 2" is assigned to an input or the functions "Control direction 1" and "Control direction 2" are each assigned to an input.
- › For "Control variant" parameters, choose the "Variant 2" option. In this variant, the control unit automatically switches to open mode if an input is permanently set with the function "Control direction 1" or "Control direction 2". ↗ Page 41, "Control variant".

3.3 Special operating modes

Operating mode	Description
Boot-up	The control unit boots up, initialises all hardware components and prepares to switch the drives on to perform homing.
Wait for homing	This operating mode is only relevant if the pedestrian gate is controlled via the API.
Perform homing	The wings are moved slowly in the direction of side 2, then in the direction of side 1 and then to the "Closed" position. The homing serves to exclude a mechanical defect and to find the position "Closed".
Critical error	An unrecoverable error was detected, e.g. a defective motor drive, I/O extension, etc. The control unit of the pedestrian gate must be reset. If the critical error continues to appear, a service technician is required.
Emergency mode	<p>If an input is set with the "Emergency open" function or if an input is no longer set with the " Emergency open" function, the control unit switches to emergency mode. The wings are opened and then powered down.</p> <p>As soon as the input is no longer set with the "Emergency open" function or if the input is again set with the " Emergency open" function, the behaviour of the control unit depends on the setting of the "Emergency options" parameter:</p> <ul style="list-style-type: none"> › Option "Auto recovery": The control unit automatically switches to normal mode. › Option "None": A reset is required for the control unit to switch to normal mode. <p>Parameter "Emergency options": ↗ Page 42, "Emergency options".</p> <p>Reset: ↗ Page 69, chapter 7.4.</p>

Table 7: Special operating modes

3.4 Control of the passages with "Control direction 1" and/or "Control direction 2"

3.4.1 Explanations

You have the option to control the behaviour of the pedestrian gate using the input functions "Control direction 1", "Control direction 2" and "Control open mode".

In addition, the parameters "Control variant" and "Delay permanent open" must be parameterised. ↗ Page 41, "Control variant" And ↗ Page 41, "Delay permanent open".

Input functions "Control direction 1" and "Control direction 2"

With every state change "not set to set" you add a validation in the corresponding direction. If the signal is longer than the time set for the "Delay permanent open" parameter, the free passage in the corresponding direction is possible.

Parameter "Control variant"

Use this parameter to select the mode for the "Control direction 1", "Control direction 2" and "Control open mode" inputs.

- › Variant 1: This variant is using the "Control direction 1", "Control direction 2" and "Control open mode" inputs. The open mode variants are selected with the "Control open mode" input.
- › Variant 2: This variant is using only the "Control direction 1" and "Control direction 2" inputs. If one of the inputs is permanently set, the corresponding open mode variant is automatically selected.

Parameter "Delay permanent open"

You use this parameter to specify whether and after what time the permanent open is activated for a permanent signal at the "Control direction 1" or "Control direction 2" input. Before the set time, a status change "not set to set" triggers a validation. After the set time, the control unit switches to Permanent open.

Chapter 3.4.2 and 3.4.3

The chapters 3.4.2 and 3.4.3 show the resulting operating mode and the resulting control unit behaviour depending on the input functions "Control direction 1" and "Control direction 2". Please also note the parameter descriptions "Control variant" and "Delay permanent open".

The following symbols and abbreviations are used in the tables:

Symbol	Description
✓	Set
✘	Not set
—	Not relevant
OM (Open mode)	The abbreviation OM indicates the open mode variant of the operating mode. In the open mode variants, the wings always remain open. The wings are only closed in the event of an unauthorised access attempt.

Table 8: Symbol and abbreviation explanation

3.4.2 Parameter "Control variant" – Option "Variant 1"

This chapter describes the control unit behaviour if the option "Variant 1" was selected for the "Control variant" parameter.

"Variant 1" is using the "Control direction 1", "Control direction 2" and "Control open mode" inputs. The open mode variants are selected with the "Control open mode" input.

- › Operating mode descriptions: ↗ Page 13, chapter 3.1.
- › Open mode: ↗ Page 18, "OM (Open mode)".
- › Parameter "Control variant": ↗ Page 41, "Control variant".

Input "Control direction ..."		Validation by changing from not set to set at input "Control direction ..."		Permanent signal at input "Control direction ..."		Resulting operating mode
1	2	1	2	1	2	Resulting control unit behaviour
						Invalid
x	x	–	–	–	–	This variant is available in the following cases: <ul style="list-style-type: none"> › The pedestrian gate is controlled via API. › An input with a specific operating mode is set. The validations are performed via the inputs with the functions "Validation direction 1" or "Validation direction 2".
						Contr. D1+D2
✓	✓	x	x	x	x	Wait for a validation in direction 1 or direction 2.
✓	✓	✓	x	x	x	Perform a passage in direction 1.
✓	✓	x	✓	x	x	Perform a passage in direction 2.
✓	✓	✓	✓	x	x	Depending on the sequence of validations performed, perform passages in direction 1 or in direction 2.
						Free D1/Contr. D2
✓	✓	–	–	✓	x	Wait for a free passage in direction 1 or for an incoming validation in direction 2.

Operation modes

Input "Control direction ..."		Validation by changing from not set to set at input "Control direction ..."		Permanent signal at input "Control direction ..."		Resulting operating mode Resulting control unit behaviour
1	2	1	2	1	2	
						Contr. D1/Free D2
✓	✓	–	✓	✓	✗	Wait for an incoming validation in direction 1 or a free passage in direction 2.
						Free D1/Contr. D2
✓	✓	–	–	✗	✓	Process passage in direction 2. Before the validated passage in direction 2 can be performed, the passage in direction 1 must be completed.
						Contr. D1/Free D2
✓	✓	✓	–	–	✓	Process passage in direction 1. Before the validated passage in direction 1 can be performed, the passage in direction 2 must be completed.
						Free D1+D2
✓	✓	–	–	✓	✓	Process free passage in direction 1 or direction 2.
						Contr. D1/Closed D2
✓	✗	✗	–	✗	–	Wait for a validation in direction 1.
✓	✗	✓	–	✗	–	Process passage in direction 1.
						Free D1/Closed D2
✓	✗	✗	–	✓	–	Process free passages in direction 1.
						Closed D1/Contr. D2
✗	✓	–	✗	–	✗	Wait for a validation in direction 2.
✗	✓	–	✓	–	✗	Process passage in direction 2.
						Closed D1/Free D2
✗	✓	–	✗	–	✓	Process free passages in direction 2.

Table 9: Parameter "Control variant" – Option "Variant 1"

3.4.3 Parameter "Control variant" – Option "Variant 2"

This chapter describes the control unit behaviour if the option "Variant 2" was selected for the "Control variant" parameter.

"Variant 2" is using only the "Control direction 1" and "Control direction 2" and "Control open mode" inputs. In this variant, the control unit automatically switches to open mode if an input is permanently set with the function "Control direction 1" or "Control direction 2".

The "Open mode control" input is not used.

- › Operating mode descriptions: ↗ Page 13, chapter 3.1.
- › Open mode: ↗ Page 18, "OM (Open mode)".
- › Parameter "Control variant": ↗ Page 41, "Control variant".

Input "Control direction ..."		Validation by changing from not set to set at input "Control direction ..."		Permanent signal at input "Control direction ..."		Resulting operating mode Resulting control unit behaviour
						Invalid
x	x	–	–	–	–	This variant is available in the following cases: <ul style="list-style-type: none"> › The pedestrian gate is controlled via API. › An input with a specific operating mode is set. The validations are performed via the inputs with the functions "Validation direction 1" or "Validation direction 2".
						Contr. D1+D2
✓	✓	x	x	x	x	Wait for a validation in direction 1 or direction 2.
✓	✓	✓	x	x	x	Perform a passage in direction 1.
✓	✓	x	✓	x	x	Perform a passage in direction 2.
✓	✓	✓	✓	x	x	Depending on the sequence of validations performed, perform passages in direction 1 or in direction 2.
						Free D1/Contr. D2 OM
✓	✓	–	–	✓	x	Wait for a free passage in direction 1 or for an incoming validation in direction 2

Operation modes

Input "Control direction ..."		Validation by changing from not set to set at input "Control direction ..."		Permanent signal at input "Control direction ..."		Resulting operating mode
1	2	1	2	1	2	Resulting control unit behaviour
						Contr. D1/Free D2 OM
✓	✓	–	✓	✓	✗	Wait for an incoming validation in direction 1 or a free passage in direction 2.
						Free D1/Contr. D2 OM
✓	✓	–	–	✗	✓	Process passage in direction 2. Before the validated passage in direction 2 can be performed, the passage in direction 1 must be completed.
						Contr. D1/Free D2 OM
✓	✓	✓	–	–	✓	Process passage in direction 1. Before the validated passage in direction 1 can be performed, the passage in direction 2 must be completed.
						Free D1+D2 OM
✓	✓	–	–	✓	✓	Process free passage in direction 1 or direction 2.
						Contr. D1/Closed D2
✓	✗	✗	–	✗	–	Wait for a validation in direction 1.
✓	✗	✓	–	✗	–	Process passage in direction 1.
						Free D1/Closed D2 OM
✓	✗	✗	–	✓	–	Process free passages in direction 1.
						Closed D1/Contr. D2
✗	✓	–	✗	–	✗	Wait for a validation in direction 2.
✗	✓	–	✓	–	✗	Process passage in direction 2.
						Closed D1/Free D2
✗	✓	–	✗	–	✓	Process free passages in direction 2.

Table 10: Parameter "Control variant" – Option "Variant 2"

4 Digital inputs, digital outputs and relay outputs

⚠ WARNING



Improper wiring and parameterisation of the control unit!

Improper wiring and parameterisation of the control unit can lead to undesired functions and thus to injuries.

- › Only MHTM™ FlowMotion® service experts or skilled technicians or electrical safety experts may wire up and parameterise the control unit.
- › The electrical connection of the signal transmitters to the IN1 to IN8 inputs must fit the parameterisation.

➤ For parameterisation see ➤ Page 29, chapter 5.

4.1 Digital inputs

By parameterising the inputs, you assign certain functions to the inputs. Example: If you parameterise the "Emergency open" function for input IN1, you must connect a fire alarm signal to this input. If the signal is interrupted (fire alarm active), the pedestrian gate is set to emergency mode.

If the function is marked with "|", the input is inverted (Fail Safe), i.e. the function is activated when the signal is interrupted.

The following functions are assigned to the inputs as default settings.

Clamp	Description	Function
IN1	Digital Input 1	Emergency open
IN2	Digital Input 2	Control direction 2
IN3	Digital Input 3	Control direction 1
IN4	Digital Input 4	Control open mode
IN5	Digital Input 5	Random check function
IN6	Digital Input 6	No access
IN7	Digital Input 7	Free D1+D2 OM
IN8	Digital Input 8	RGB illumination off

Table 11: Factory settings "Digital inputs"

Digital inputs, digital outputs and relay outputs

Function	Description
–	Inputs that you assign the function "–" to are being deactivated.
Emergency open	<p>Emergency</p> <p>Connect fire service switches, emergency opening contacts, etc. to this input. As soon as this input is set, the control unit switches to emergency mode. The wings are opened and then powered down.</p> <p>This input function is high priority to all other input functions.</p>
Emergency open	<p>Emergency situation (Fail Safe)</p> <p>Connect fire service switches, emergency opening contacts, etc. to this input. As long as this input is set, the pedestrian gate is in operation. As soon as this input is no longer set, the control unit switches to emergency mode. The wings are opened and then powered down.</p> <p>This input function is high priority to all other input functions.</p>
Reset	<p>You restore the control unit via this input.</p> <p>In following cases a reset may be required:</p> <ul style="list-style-type: none"> › After an emergency, if the option "None" is set. ↗ Page 42, "Emergency options". › After an error (ERROR) has occurred.
Control direction 1	<p>Validation in direction 1 or Permanent open in direction 1</p> <p>With every state change "not set to set" you add a validation in direction 1. If the signal is longer than the time set for the "Delay permanent open" parameter, the free passage in direction 1 is possible. ↗ Page 41, "Delay permanent open".</p>
Control direction 2	Function such as "Control direction 1" but for direction 2.
Control open mode	<p>The input functions are only effective in the following cases: The function "Control direction 1" is assigned to an input or the function "Control direction 2" is assigned to an input or the functions "Control direction 1" and "Control direction 2" are each assigned to an input. ↗ Page 17, chapter 3.4.</p> <p>Basically, the wings remain closed until a validation is provided or until a person enters the pedestrian gate in the free direction.</p> <p>If you assign and set this function to an input, the wings are always open and only close in the event of unauthorised access attempts.</p>
Validation direction 1	<p>With every state change "not set to set" you provide a validation in direction 1.</p> <p>In contrast to the input function "Control direction 1", permanently setting the input has no effect on the current operating mode. If the current operating mode does not allow validations in direction 1, the input signal is ignored.</p>
Validation direction 2	Function such as "Validation direction 1" but for direction 2.

Digital inputs, digital outputs and relay outputs

Function	Description
Random check function	<p>Activate random check function, confirm hits</p> <p>As soon as this input is set, the random check function is activated. ↗ Page 56, chapter 6.2.7, "Random check function" menu.</p> <p>If a random hit occurs, the output is set with the "Random hit" function. The currently validated passage is closed. To confirm the hit, the input must be cleared for at least 50 ms. Only then can the input again be set to reactivate the random generator.</p>
RGB illumination off	<p>Switching the lighting off and on</p> <p>When this input is set, the illumination assigned to the "RGB1 red", "RGB2 blue", etc. functions is turned off.</p>
No access	↗ Page 13, chapter 3.1.
Free D1+D2	↗ Page 13, chapter 3.1.
Free D1+D2 OM	↗ Page 13, chapter 3.1.
Free D1/Closed D2	↗ Page 13, chapter 3.1.
Free D1/Closed D2 OM	↗ Page 13, chapter 3.1.
Closed D2/Free D2	↗ Page 13, chapter 3.1.
Closed D2/Free D2 OM	↗ Page 13, chapter 3.1.
Contr. D1/Free D2	↗ Page 13, chapter 3.1.
Contr. D1/Free D2 OM	↗ Page 13, chapter 3.1.
Free D1/Contr. D2	↗ Page 13, chapter 3.1.
Free D1/Contr. D2 OM	↗ Page 13, chapter 3.1.
Contr. D1/Closed D2	↗ Page 13, chapter 3.1.
Contr. D1/Closed D2 OM	↗ Page 13, chapter 3.1.
Closed D1/Contr. D2	↗ Page 13, chapter 3.1.
Closed D1/Contr. D2 OM	↗ Page 13, chapter 3.1.
Contr. D1+D2	↗ Page 13, chapter 3.1.
Contr. D1+D2 OM	↗ Page 13, chapter 3.1.

Table 12: Function Digital inputs

4.2 Digital outputs and relay outputs

By parameterising the outputs, you assign certain functions to the outputs. For example, if you parameterise the "Buzzer (static)" function for output NO2, you must connect an acoustic signal transmitter to this output.

If the function is marked with "|", the output is inverted (Fail Safe).

The following functions are assigned to the outputs as default settings.

Clamp	Description	Function
DO1	Digital output 1	GED 2 red
DO2	Digital output 2	GED 2 green
DO3	Digital output 3	GED 1 red
DO4	Digital output 4	GED 1 green
NO1	Relay output 1	Random hit
NO2	Relay output 2	Buzzer (static)
NO3	Relay output 3	Fraud
NO4/NC4	Relay output 4	Hold-open time D1
NO5/NC6	Relay output 5	Hold-open time D2
NO6/NC6	Relay output 6	Wings closed

Table 13: Factory settings Digital outputs and Relay outputs

Function	Description
–	Outputs that you assign this function "–" to are deactivated.
Error	When the control unit detects an "Error", the output is set with this function.
Error	As long as the control unit detects neither a "safety-relevant error" nor an "error", the output is set with this function.
Wings closed	Both wings are in closed position.
Wings opened	Both wings are open either in direction 1 or in direction 2.
Wings opened D1	Both wings are currently opened in direction 1.
Wings opened D2	Both wings are currently opened in direction 2.
Wings locked	Both wings are currently locked mechanically. You cannot move the wings by hand.
Random hit	Hits of the random check function The random check function generated a hit. You can connect a signal lamp or a buzzer to this output, for example. The passage remains blocked until the random hit or validation is confirmed with a 0 V pulse at the "random check function" input.

Function	Description
Buzzer	<p>To this output you connect a buzzer that does not generate its own beep pattern. The buzzer generates the beep pattern depending on the switching status of the output.</p> <p>The output is set when the selected events occur. The events are selected using the "Buzzer" parameter. ↗ Page 52, "Buzzer (Menu)".</p> <p>IMPORTANT! Assign this function to a digital output. When using a relay output, the life of the dry contact may be shortened if the buzzer is switched on frequently.</p> <p>Alternatively, you may use the "Buzzer (static)" output.</p>
Buzzer (static)	<p>To this output you connect a buzzer with an integrated beep pattern.</p> <p>The output is set when the selected events occur. The events are selected using the "Buzzer" parameter. ↗ Page 52, "Buzzer (Menu)".</p> <p>In contrast to the "Buzzer" function, this output is set statically.</p>
Passage clear	This output is activated when there is no person in the passage.
Passage clear D1	This output is activated if no person is detected in the passage who has entered on side 1.
Passage clear D2	Function such as "Passage clear D1" but for direction 2.
Val. pers. present	This output is activated when a validated person is still in the passage.
Val. pers. present D1	This output is activated when a validated person, who entered on side 1, is still in the passage.
Val. pers. present D2	Function such as "Val. pers. present 1" but for direction 2.
Val. pers. passed	This output generates a pulse with a duration of 300 m for each validated person passing the passage.
Val. pers. Passed D1	Function such as "Val. pers. Passed 1" but only for direction 1.
Val. pers. Passed D2	Function such as "Val. pers. Passed 2" but only for direction 1.
Fraud	An unauthorised access attempt such as "Intrusion", "Wrong direction" or "Tailgating" was detected in one direction. ↗ Page 12, chapter 2.2.
Fraud direction 1	Function such as "Fraud" but only for direction 1.
Fraud direction 2	Function such as "Fraud" but only for direction 2.
Intrusion	An unauthorised access attempt of the "Intrusion", type was detected in one direction. ↗ Page 12, chapter 2.2.
Intrusion D1	Function such as "Intrusion" but only for direction 1.
Intrusion D2	Function such as "Intrusion" but only for direction 2.
Wrong direction	An unauthorised access attempt of the "Wrong direction", type was detected in one direction. ↗ Page 12, chapter 2.2.
Wrong direction D1	Function such as "Wrong direction" but only for direction 1.
Wrong direction D2	Function such as "Wrong direction" but only for direction 2.

Digital inputs, digital outputs and relay outputs

Function	Description
Tailgating	An unauthorised access attempt of the "Tailgating", type was detected in one direction. ↗ Page 12, chapter 2.2.
Tailgating D1	Function such as "Tailgating" but only for direction 1.
Tailgating D2	Function such as "Tailgating" but only for direction 2.
Wing forced open	One wing was opened by force. This output is activated for 10 s.
Hit obstacle	A wing has hit an obstacle when opening or closing. This output is activated for 10 s.
Warning light barriers (PE beams)	This output is activated if one of the light barriers (PE beams) is occupied for longer than the set time. ↗ Page 52, "Warning light barriers (Parameter)".
GED1 red	Gate End Display connection Connect the GED red in side 1 to this output.
GED1 green	Gate End Display connection Connect the GED green in side 1 to this output.
GED2 red	Gate End Display connection Connect the GED red in side 2 to this output.
GED2 green	Gate End Display connection Connect the GED green in side 2 to this output.

Table 14: Function digital outputs and relay outputs

5 Parameterising control unit

5.1 Changing menu language

The default setting in the MGCplus control unit is the menu language "English".

Change the menu language as follows:

The operational view is displayed.

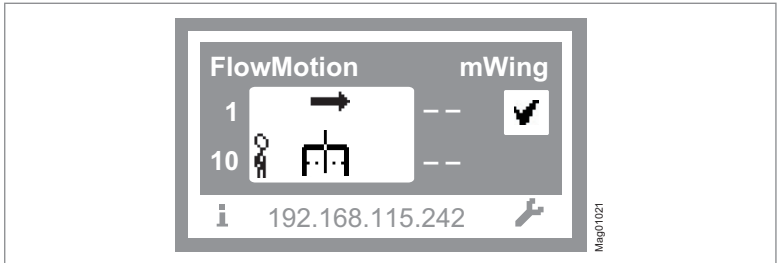



Fig. 2: Example "Operational view"

1. Press right operating button «».
2. Access to parameterisation can be password-protected. If password protection was activated, you are asked to enter a password.

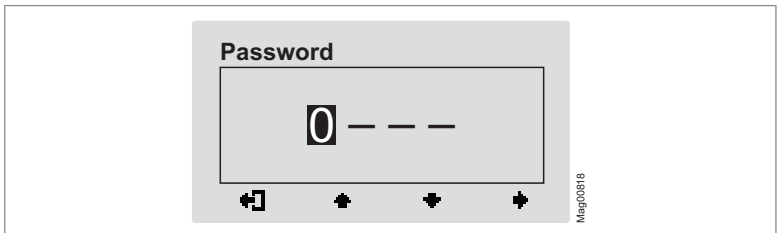

Fig. 3: View "Enter password"

Parameterising control unit

3. The "Main menu" menu is displayed. The "Settings" menu has a dark background and is thus selected.

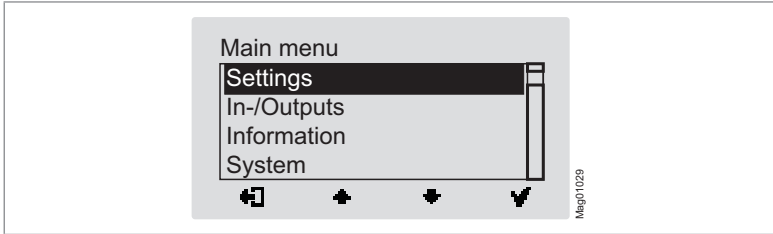

Fig. 4: View "Main menu – Settings"

4. Select the "System" menu with the two middle buttons «+», «-».

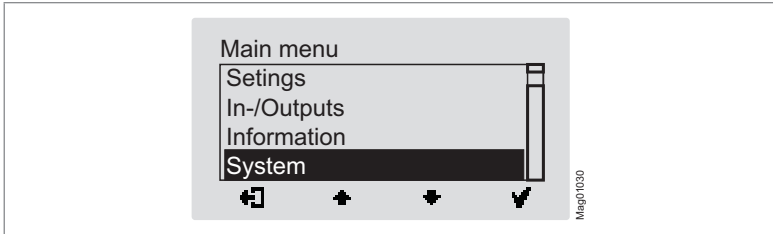

Fig. 5: View "Main menu – System"

5. Confirm selection with the right control button «✓». The "Reboot" menu.
6. Select the "Language" menu with the two middle buttons «+», «-».

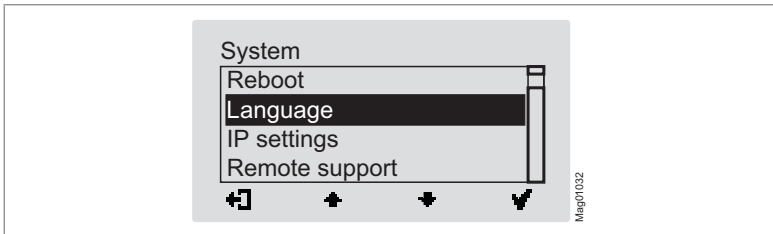



Fig. 6: View "Language"

7. Confirm selection with the right button «». The following view is displayed. The menu language "English" is chosen.

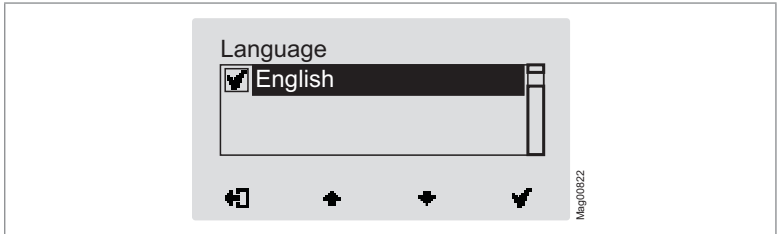



Fig. 7: View "Language – English"

8. Select the language "German" with the two middle buttons «», «». The language "German" has a dark background.

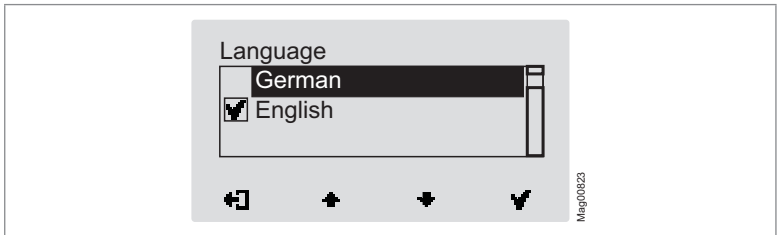



Fig. 8: View "Language – German"

9. Use the right button «» to select the new menu language. Your selection is marked with the symbol «».

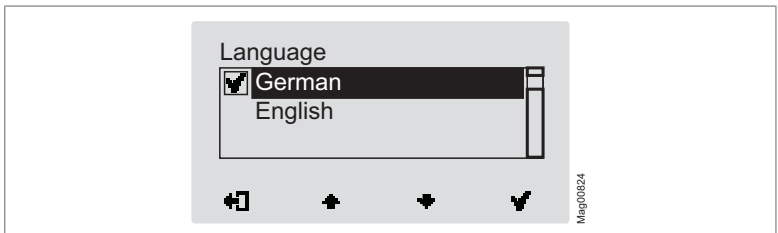

Fig. 9: View "Language – German, step 2"

Parameterising control unit

- 10. Use the left button «**+**» to leave the "Language" menu. The safety prompt "Save changes?" appears.

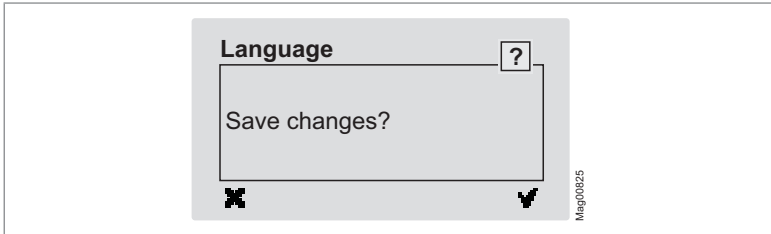

Fig. 10: View "Safety prompt – Save changes?"

Push the left button «**+**» if you do not want to save the changes. The menu language "English" remains active.

- 11. Confirm safety prompt with the right button «**✓**». The new menu language "German" is activated. The following view is displayed:

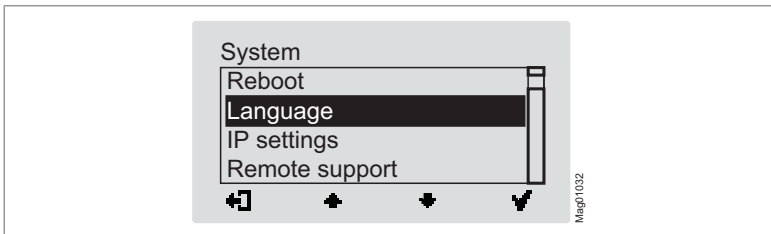

Fig. 11: View "System" menu – Menu language "German" is activated

- 12. Press the left button «**+**» repeatedly until the operational view is displayed again. ↗ Page 11, Fig. 1.

5.2 Entering password

You need to enter a password in the following cases:

- › You would like to change parameters in the control unit and the password protection was activated.
- › You would like to reset the parameters to factory settings.

If a password is required, the following view is displayed:

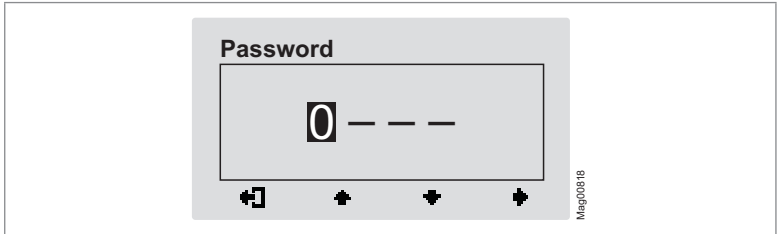





Fig. 12: View "Enter password"

1. Use the two middle buttons «», «» to enter the first digit of the password.
2. Use the right button «» to select the second digit of the password. The following view is displayed:

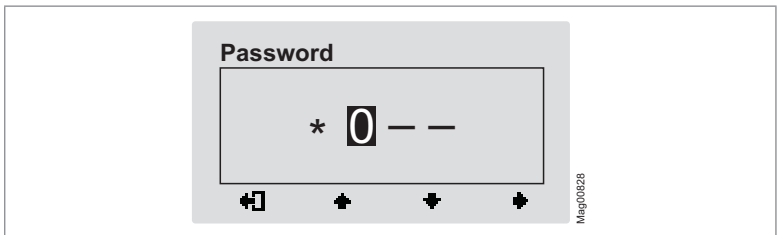







Fig. 13: View "Enter second digit of the password"

3. Use the two middle buttons «», «» to enter the second digit of the password.
4. Use the right button «» to select the third digit of the password.
5. Use the two middle buttons «», «» to enter the third digit of the password.

Parameterising control unit

- Use the right button «**➡**» to select the fourth digit of the password. The following view is displayed:

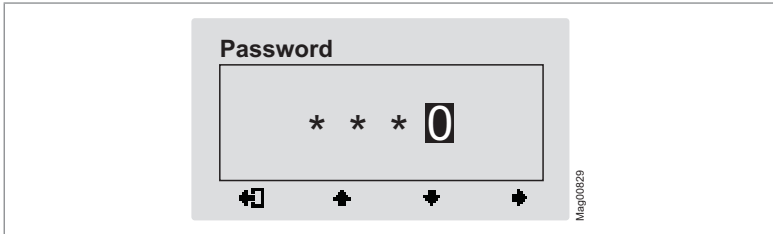

Fig. 14: View "Enter fourth digit of the password"

- Use the two middle buttons «**➡**», «**➤**» to enter the fourth digit of the password.
- Confirm the password with the right control button «**➡**».

5.3 Control unit elements

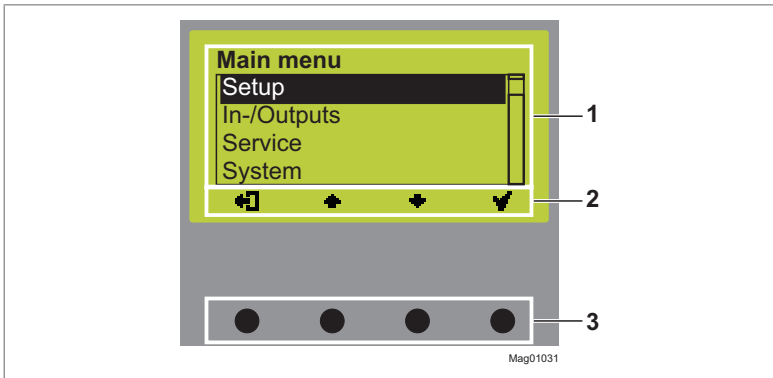

Fig. 15: MGCplus control unit elements

- Menu
- Current function of the 4 control buttons
- Control buttons

5.4 Displays of the control unit

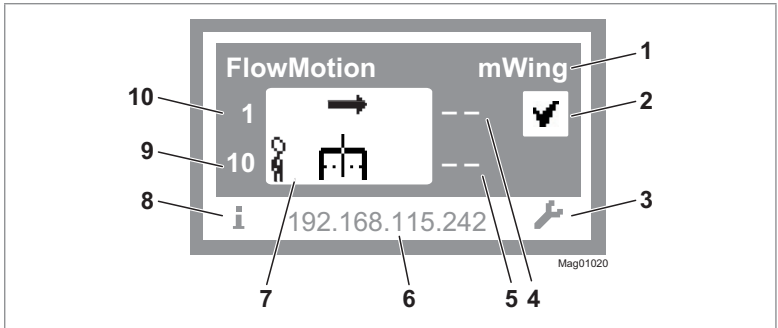

Fig. 16: Example "Operational view"

- 1 Type pedestrian gate, here "mWing"
- 2 Status display, here ready for operation
- 3 Current function of the right control button, here calling menu "Main menu"
- 4 Validations in passage direction 2, here closed (no validations)
- 5 Hold-open time in passage direction 2, here closed (no validations)
- 6 IP address
- 7 Operating display, here passage direction 1 enabled
- 8 Current function of the left control button, here calling menu "Information"
- 9 Holding-open time in passage direction 1, here 10
- 10 Remaining validations, passage direction 1, here 1

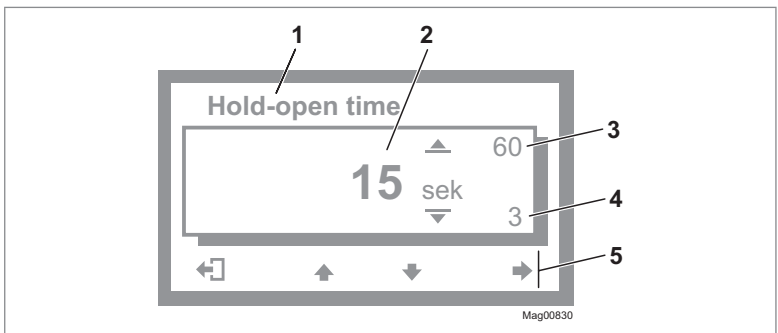

Fig. 17: Example "Screen Change Value"

- 1 Parameter
- 2 Current value
- 3 Possible upper value
- 4 Possible lower value
- 5 Current functions of the control buttons

5.5 Symbols in the display

5.5.1 Control button functions

The control unit is equipped with 4 control buttons. The function of the control buttons change depending on the current view in the display. The current functions are shown in the display.

Clamp	Description
	<ul style="list-style-type: none"> › Call menu "Information". › Scroll menu "Information".
	Call menu "Main menu". Make all settings in the menu "Main menu".
	Leave current menu level. The next-higher menu level is displayed.
	<ul style="list-style-type: none"> › Call next-lower menu level. › Select desired option or desired value. When the desired option was selected, the symbol
	Option was selected but not yet stored
	<ul style="list-style-type: none"> › Within one menu level: Move cursor (market) upwards. › For setting value: Increase figure.
	<ul style="list-style-type: none"> › Within one menu level: Move cursor (market) downwards. › For setting value: Decrease figure.
	Move cursor one position to the right.
	<ul style="list-style-type: none"> › Delete error message. › When changing settings: Cancel changing process.

Table 15: Control button functions

5.5.2 Further symbols











Clamp	Description
	Wrong password entered. Access denied.
	The next validation is blocked by the random check function.
	There is information. Check the "Information" menu. To do this, press the left operating button.
	There is a warning. Check the "Information" menu. To do this, press the left operating button.
	There is an error. Check the "Information" menu. To do this, press the left operating button.
	One passage direction is enabled.
	The passage is enabled in both directions.

Table 16: Further symbols

5.6 Setting display contrast

The display contrast of the control unit is adjustable after activation while the logo is still displayed. The logo is displayed for 3 seconds.

If you push one of the middle buttons «», «», the display time of the logo extends by 2 seconds per push. You can thus extend the time to set the display contrast.

- › Increase contrast, display grows darker: Press the «» button.
- › Reduce contrast, display grows lighter: Press the «» button.

The set display contrast is saved automatically.











5.7 Protecting parameterisation from access







You can apply the access to the main menu with password protection. ↗ Page 63, "Main menu password".

5.8 Parameterise value

Example: Change hold-open time

The operational view is displayed. ↗ Page 29, Fig. 2.

1. Press the right button «».
 - ✓ The "Main menu" menu is displayed.
2. Select the "Settings" menu with the two middle buttons «», «».
3. Confirm the selection with the right button «».
4. The "Hold-open time" parameter has a dark background and is thus selected. If necessary, use the two middle buttons «», «» to select the "Hold-open time" parameter.
5. Press the right button «».
 - ✓ The current hold-open time value is displayed. The cursor flashes on the first digit.
6. Use the middle buttons «», «» to set the desired digit.
7. Use the right button «» to move the cursor to the right.
 - ✓ The cursor flashes on the second digit.

8. Use the middle buttons «», «» to set the desired digit.
9. Press the right button «».
10. Use the left button «» to leave the "Hold-open Time" parameter.
 - ✓ The safety prompt "Save changes?" appears.
11. If the changes are to be saved, press the right button «». The new hold-open time is activated.
If the changes are not to be saved, press the left button «». The previous hold-open time remains active.
 - ✓ The "Settings" menu is displayed.
12. Press the left button «» repeatedly until the operational view is displayed again.

5.9 Switching the "Service" mode on and off

In service mode, all opening signals are ignored.

Switch on mode "Service"

Switch the "Service" switch for the "Service" mode. The LED lights red. The display backlighting flashes.

Switch off mode "Service"

After the service work, the switch "Service" must be switched. The LED must light green.

6 Description of menus and parameters

6.1 Menu "Information"

Call and navigate

The operational view is displayed. ↗ Page 29, Fig. 2.

1. Press left button «**i**».
2. Use the left button «**i**» to scroll within the menu.
3. The "Information" menu can be left as follows:
 - › Press the left button «**i**» repeatedly until the operational view is displayed again or
 - › press the right button «**+**».

Operational view > Information	
Parameter	Description
Error, warning or event messages	Display of the error, warning or event messages that occurred since the last voltage reset, including date and time. Use the « + » and « - » buttons to navigate through the messages. If no messages are present, the menu is not displayed.
Inputs	Displays the current settings for the digital inputs IN1 to IN8. Inputs with inverted functions are marked with a " ", e.g. "IN1: Emergency open".
Outputs	Displays the current settings for the digital outputs DO1 to DO4 and the relay outputs NO1 to NO3 and NO/NC4 to NO/NC6. Outputs with inverted functions are marked with a " ", e.g. "DO4: GED1 green".
Light barriers (PE beams)	Displays the occupation state of the light barriers (PE beams).

Table 17: Menu "Information"

6.2 Menu "Settings"

6.2.1 Operating mode

Operational view > Main menu > Settings > Operating mode	
Parameter	Description
Control variant	<p>Select mode for the "Control direction 1", "Control direction 2" and "Control open mode" inputs.</p> <p>Options</p> <ul style="list-style-type: none"> › Variant 1: This variant is using the "Control direction 1", "Control direction 2" and "Control open mode" inputs. The open mode variants are selected with the "Control open mode" input. › Variant 2: This variant is using only the "Control direction 1" and "Control direction 2" inputs. If one of the inputs is permanently set, the corresponding open mode variant is automatically selected. <p>↗ Page 19, chapter 3.4.2 and ↗ Page 21, chapter 3.4.3.</p> <p>Factory setting</p> <ul style="list-style-type: none"> › Variant 1:
Delay permanent open	<p>You use this parameter to specify whether and after what time the permanent open is activated for a permanent signal at the "Control direction 1" or "Control direction 2" input.</p> <p>Options</p> <ul style="list-style-type: none"> › Inactive: Each status change "not set to set" triggers a validation. › After 3 s › After 10 s <p>Example: "After 3 s"</p> <p>If a signal contacts the "Control direction 1" or "Control direction 2" input for at least 3 seconds, the control unit switches to Permanent open. This means that a person entering the pedestrian gate in this direction is automatically validated. As soon as the signal no longer contacts the input, the control unit switches back to a controlled operating mode such as "Contr. D1/Closed D2".</p> <p>Factory setting</p> <ul style="list-style-type: none"> › After 3 s

Description of menus and parameters

Operational view > Main menu > Settings > Operating mode	
Parameter	Description
Emergency options	<p>Set the control unit behaviour during an emergency.</p> <p>If an input is set with the "Emergency open" function or if an input is no longer set with the " Emergency open" function, the control unit switches to emergency mode.</p> <p>As soon as the input is no longer set with the "Emergency open" function or if the input is again set with the " Emergency open" function, the behaviour of the control unit depends on the setting of the "Emergency options" parameter.</p> <p>Options</p> <ul style="list-style-type: none"> > None: A reset is required for the control unit to switch to normal mode. <ul style="list-style-type: none"> ➤ Page 69, chapter 7.4. > Auto recovery: The control unit automatically switches to normal mode. <p>Factory setting</p> <ul style="list-style-type: none"> > Auto recovery

Table 18: Operating mode

6.2.2 Validations

Operational view > Main menu > Settings > Validations	
Parameter	Description
Hold-open Time – Change	<p>Set the hold-open time.</p> <p>The hold-open time is started by an opening pulse by a control device, such as a card reader. Within the set hold-open time, one passage must be commenced. If the hold-open time reaches "0 s" and no person has entered the pedestrian gate, the validation is lost.</p> <p>Depending on the parameterisation, it is possible that the passage remains open because further validations are pending.</p> <p>With the setting "0 s", the person must already be in the pedestrian gate and be detected by the light barriers (PE beams), or the validation is lost immediately.</p> <p>Once a person has been validated, this validation is maintained until the person leaves the pedestrian gate in any direction.</p> <p>Setting range</p> <ul style="list-style-type: none"> > 0 to 3600 s (1 hour) <p>Factory setting</p> <ul style="list-style-type: none"> > 15 s
Hold-open Time – Set to:	Shows the set hold-open time.
Hold-open Time – Remaining time	Shows the remaining hold-open time.

Operational view > Main menu > Settings > Validations	
Parameter	Description
Close delay – change	<p>Set close delay.</p> <p>The closing delay is the additional time that the wings remain open after a validated person has passed.</p> <p>Changing the closing delay is useful:</p> <ul style="list-style-type: none"> › If the safety of persons is to be increased. › If the throughput rate is to be increased during high-traffic times. As the wings remain open during the closing time, the time for the following validated passage will be reduced. <p>The close delay is immediately cancelled for any unauthorised access attempt.</p> <p>Setting range</p> <ul style="list-style-type: none"> › 0 to 60 s <p>Factory setting</p> <ul style="list-style-type: none"> › 1 s
Close delay – set	Shows the set close delay.
Close delay – Remaining time	Shows the remaining close delay.
Left direction 1	Shows the remaining validations in direction 1.
Left direction 2	Shows the remaining validations in direction 2.
Max. direction 1	<p>Limit the maximum number of validations for direction 1 that can be stored.</p> <p>Options</p> <ul style="list-style-type: none"> › 0: no limitation › 1: Only one validation in direction 1 is possible at one time. › 2: Two pending validations in direction 1 are possible at one time. <p>etc.</p> <p>Setting range</p> <ul style="list-style-type: none"> › 0 to 65535 <p>Factory setting</p> <ul style="list-style-type: none"> › 0
Max. direction 2	Function such as "Max. direction 1" but for direction 2.
Manual validation D1	<p>Change validations in direction 1 and test function.</p> <p>Options</p> <ul style="list-style-type: none"> › Clear all: Clear all pending validations. › 1 Validation: 1 validation entered in direction 1. › 2 Validation: 2 validations entered in direction 1. <p>etc.</p> <p>Factory setting</p> <ul style="list-style-type: none"> › Clear all

Description of menus and parameters

Operational view > Main menu > Settings > Validations	
Parameter	Description
Manual validation D2	Function such as "Manual validation D1" but for direction 2.

Table 19: Validations

6.2.3 Speed Wings

Operational view > Main menu > Settings > Wing speed	
Parameter	Description
Opening speed	<p>Select the speed for opening the wings.</p> <p>Options</p> <ul style="list-style-type: none"> > Slower > Slow > Medium > Fast > Faster <p>Factory setting</p> <ul style="list-style-type: none"> > Fast
Closing speed	<p>Select the speed for closing the wings.</p> <p>IMPORTANT! The closing speed for unauthorised access attempts is parameterised via the "Speed on fraud" parameter. ↗ Page 44, "Speed on fraud".</p> <p>Options</p> <ul style="list-style-type: none"> > Slower > Slow > Medium > Fast > Faster <p>Factory setting</p> <ul style="list-style-type: none"> > Fast
Speed on fraud	<p>Select the speed for closing the wings for unauthorised access attempts.</p> <p>Options</p> <ul style="list-style-type: none"> > Slower > Slow > Medium > Fast > Faster <p>Factory setting</p> <ul style="list-style-type: none"> > Fast

Table 20: Speed Wings

6.2.4 Safety

6.2.4.1 General



Operational view > Main menu > Settings > Safety > General	
Parameter	Description
Disable safety	<p>Enable and disable the test of the safety light barriers (safety PE beams). By default, the safety light barriers (safety PE beams) are checked before each opening or closing of the wings.</p> <p>Options</p> <ul style="list-style-type: none"> › Inactive []: The test of the safety light barriers (safety PE beams) is enabled. › Activated [X]: The test of the safety light barriers (safety PE beams) is disabled. <p>Factory setting</p> <ul style="list-style-type: none"> › Inactive []:
Impact response Open	<p>Select the response for obstacle detection during the opening of the wings. An obstacle could be, for example, a stopping user or a trapped piece of luggage.</p> <p>Options</p> <ul style="list-style-type: none"> › None: The control unit attempts to continue the opening process of the wings. › Lock › Close again › Open again › Disable power <p>Factory setting</p> <ul style="list-style-type: none"> › Close again
Impact delay Open	<p>Set the duration of the response for obstacle detection during the opening. ↗ Page 45, "Impact response Open".</p> <p>Options</p> <ul style="list-style-type: none"> › 3 s, 5 s, 7 s, 10 s or 15 s <p>Factory setting</p> <ul style="list-style-type: none"> › 5 s

Description of menus and parameters

Operational view > Main menu > Settings > Safety > General	
Parameter	Description
Impact response Close	<p>Select the response for obstacle detection during the closing of the wings.</p> <p>IMPORTANT! The response for unauthorised access attempts is parameterised via the "Impact response Close" parameters of the "Intrusion", "Wrong direction" and "Tailgating" menus. ↗ Page 48, chapter 6.2.4.3 up to ↗ Page 50, chapter 6.2.4.5.</p> <p>Options</p> <ul style="list-style-type: none"> › None: The control unit attempts to continue the closing process of the wings. › Lock › Open again › Close again › Disable power <p>Factory setting</p> <ul style="list-style-type: none"> › Open again
Impact delay Close	<p>Set the duration of the response for obstacle detection during the closing.</p> <p>↗ Page 46, "Impact response Close".</p> <p>Options</p> <ul style="list-style-type: none"> › 3 s, 5 s, 7 s, 10 s or 15 s <p>Factory setting</p> <ul style="list-style-type: none"> › 5 s

Table 21: General

6.2.4.2 Low energy

 WARNING	
	<p>Entry of values that do not fit the blocking element!</p> <p>Entering values that do not fit the installed blocking element can lead to increased speed and incorrect torque, and thus to injuries.</p> <ul style="list-style-type: none">› Only MHTM™ FlowMotion® service experts may enter the values for safe operation.› The entered values must fit the installed blocking element.

Use the "Low energy" menu to enter the values for wing safe operation in low-energy mode in accordance with DIN EN 17352.

The values to be entered depend on the installed blocking element.

The values to be entered are on a label that is attached to the blocking element.

Adjust values for safe operation

1. Select the "Low energy" menu. Path: Operational view > Main menu > Settings > Safety > Low energy
2. Select the "New value S" parameter.
3. Enter "Service Password"
 - √ The "New value S" view is displayed.
4. Enter value "S" according to the label.
5. Confirm the safety prompt "Save changes?".
6. Perform steps 2 to 5 for the "New value T" and "New value C" parameters.
7. Select the "Adopt new values" parameter.
8. Select the "Apply values" option.
9. The settings for the "New value S", "New value T" and "New value C" parameters are stored.
10. Check "Status" parameter. If the values are correct, "ok" is displayed as status.

Description of menus and parameters

Operational view > Main menu > Settings > Safety > Low energy	
Parameter	Description
New value S	Adjust the value "S" to the installed blocking element. The adjustment requires a service password. Additionally, the current setting for the value "S" is displayed.
New value T	Adjust the value "T" to the installed blocking element. The adjustment requires a service password. Additionally, the current setting for the value "T" is displayed.
New value C	Adjust the value "C" to the installed blocking element. The adjustment requires a service password. Additionally, the current setting for the value "T" is displayed.
Adopt new values	Save all changed values in the "Low energy" menu. Options <ul style="list-style-type: none"> › No action › Adopt values
Status	Shows whether the new values are correct or incorrect.
Readback 1	Shows the current settings for the values "S" and "T" for Wing 1.
Readback 2	Shows the current settings for the values "S" and "T" for Wing 2.

Table 22: Low energy

6.2.4.3 Intrusion

Operational view > Main menu > Settings > Safety > Intrusion	
Parameter	Description
Do not close	Select the behaviour of the wings in case of an unauthorised access attempt of the "Intrusion" type. If you select the "Activated [X]" option, the wings will not be closed in the event of an unauthorised access attempt of the "Intrusion" type. Options <ul style="list-style-type: none"> › Inactive []: › Activated [X] Factory setting <ul style="list-style-type: none"> › Activated []:
Disable safety	Enable and disable the test of the safety light barriers (safety PE beams) for an unauthorised access attempt of the "Intrusion" type. ↗ Page 45, "Disable safety". Factory setting <ul style="list-style-type: none"> › Inactive []:

Operational view > Main menu > Settings > Safety > Intrusion	
Parameter	Description
Impact response Close	Select the response for obstacle detection during the closing of the wings for the unauthorised access attempt of the "Intrusion" type. ↗ Page 46, "Impact response Close". Factory setting › Lock

Table 23: Intrusion

6.2.4.4 Wrong direction

Operational view > Main menu > Settings > Safety > Wrong direction	
Parameter	Description
Do not close if free	Select the behaviour of the wings in case of an unauthorised access attempt of the "Wrong direction" type for certain operating modes. Certain operating modes are operating modes with "Free D1" or "Free D2". Example "Contr. D1/Free D2" If a validation is pending in direction 1 and a person enters the pedestrian gate in direction 2, this is an unauthorised access attempt of the type "Wrong direction". If you select the option "Activated [X]", the wings will not be closed in this case, as one passageway in direction 2 is always free. Options › Inactive []: › Activated [X] Factory setting › Inactive []:
Do not close	Select the behaviour of the wings in case of an unauthorised access attempt of the "Wrong direction" type. If you select the "Activated [X]" option, the wings will not be closed in the event of an unauthorised access attempt of the "Wrong direction" type. Options › Inactive []: › Activated [X] Factory setting › Inactive []:
Disable safety	Enable and disable the test of the safety light barriers (safety PE beams) for an unauthorised access attempt of the "Wrong direction" type. ↗ Page 45, "Disable safety". Factory setting › Inactive []:

Description of menus and parameters

Operational view > Main menu > Settings > Safety > Wrong direction	
Parameter	Description
Impact response Close	Select the response for obstacle detection during the closing of the wings for the unauthorised access attempt of the "Wrong direction" type. ↗ Page 46, "Impact response Close". Factory setting › Lock

Table 24: Wrong direction

6.2.4.5 Tailgating

Operational view > Main menu > Settings > Safety > Tailgating	
Parameter	Description
Do not close	Select the behaviour of the wings in case of an unauthorised access attempt of the "Tailgating" type. If you select the "Activated [X]" option, the wings will not be closed in the event of an unauthorised access attempt of the "Tailgating" type. Options › Inactive []: › Activated [X] Factory setting › Inactive []:
Disable safety	Enable and disable the test of the safety light barriers (safety PE beams) for an unauthorised access attempt of the "Tailgating" type. ↗ Page 45, "Disable safety". Factory setting › Inactive []:
Impact response Close	Select the response for obstacle detection during the closing of the wings for the unauthorised access attempt of the "Tailgating" type. ↗ Page 46, "Impact response Close". Factory setting › Lock

Table 25: Tailgating

6.2.5 Safety

6.2.5.1 Forced opening

Operational view > Main menu > Settings > Safety > Forced opening	
Parameter	Description
React. forced opening (Reaction forced opening)	<p>Select response if the wings are attempted to be open from the closed position by force.</p> <p>Options</p> <ul style="list-style-type: none"> > None > Lock <p>Factory setting</p> <ul style="list-style-type: none"> > Lock
Delay forced opening	<p>Select the locking time for the wings after an attempt on forced opening. After the control unit has detected an attempt on forced opening, the control unit locks the wings for the selected time. When the time expires, the control unit unlocks the wings and tries to move the wings to the "Closed" position.</p> <p>Options</p> <ul style="list-style-type: none"> > 3 s, 5 s, 7 s, 10 s or 15 s <p>Factory setting</p> <ul style="list-style-type: none"> > 10 s

Table 26: Forced opening

6.2.5.2 Lock wings autom.

Operational view > Main menu > Settings > Safety > Lock wings autom.	
Parameter	Description
Lock wings autom. (Lock wings automatically)	<p>Select positions in which the wings are automatically locked.</p> <p>Options</p> <ul style="list-style-type: none"> > Never > Closed > Open > Closed/Opened <p>Factory setting</p> <ul style="list-style-type: none"> > Never

Table 27: Lock wings autom.

Description of menus and parameters

6.2.5.3 Warning light barriers (PE beams)

Operational view > Main menu > Settings > Safety > Warning light barriers (PE beams)	
Parameter	Description
Warning light barriers (PE beams)	<p>Set the maximum time that a light barrier (PE beam) may be occupied. If one of the light barriers (PE beams) is occupied for longer than the set time, the output "Warning light barriers (PE beam)" is set. ↗ Page 28, "Warning light barriers (Output)".</p> <p>Options (adjustment range)</p> <ul style="list-style-type: none"> › 0 s to 60 s › 0 s: The output "Warning light barriers (PE beams)" is not set. <p>Factory setting</p> <ul style="list-style-type: none"> › 0 s

Table 28: Warning light barriers (PE beams)

6.2.6 Signalling

6.2.6.1 Buzzer

Operational view > Main menu > Settings > Signalling > Buzzer	
Parameter	Description
Buzzer	<p>Enable and disable events for which an acoustic signal is to be triggered. Connect the acoustic signal either to the "Buzzer" or the "Buzzer (static)" output. ↗ Page 27, "Buzzer (Output)" and ↗ Page 27, "Buzzer (static)".</p> <p>An acoustic signal is possible for the following events:</p> <ul style="list-style-type: none"> › On error › On validation › On forced opening › On fraud › After passage › On random hit <p>Options</p> <ul style="list-style-type: none"> › Inactive []: › Activated [X] <p>Factory setting</p> <ul style="list-style-type: none"> › Activated [X] for "On error", "On validation" and "On fraud"

Table 29: Buzzer

6.2.6.2 GED no. 1 / GED no. 2

The GEDs are parameterised using the "Mode", "Mode wrong direction" and "Validation response" parameters.

For certain events such as "On tailgating" etc. you can choose between different display patterns. Display pattern descriptions: ↗ Page 55, section "Display pattern on the GED".

Operational view > Main menu > Settings > Signalling > GED no. 1 / GED no. 2	
Parameter	Description
Mode	<p>Select the behaviour of the optional GED.</p> <p>Options</p> <ul style="list-style-type: none"> › Always off: The GED is dark. › Always red: The GED is permanently red. › Always green: The GED is permanently green. › Standby off: The GED is off when no validations are pending and no free passage in that direction is possible. As soon as a validation is pending or the direction is permanently free, the GED turns green. › Standby red: The GED is red when no validations are pending and no free passage in that direction is possible. As soon as a validation is pending or the direction is permanently free, the GED turns green. › Standby green: The GED is green when no validations are pending and no free passage in that direction is possible. Validations can be accepted at any time. <p>Factory setting</p> <ul style="list-style-type: none"> › Standby green
Mode wrong direction	<p>Select GED behaviour when a validated person tries passing the passage in the wrong direction.</p> <p>If no person tries to pass the passage in the wrong direction, the GED will behave in accordance with the "Mode" parameter.</p> <p>Prerequisite</p> <p>This parameter is only effective if you have selected the "Standby off", "Standby red" or "Standby green" option for the "Mode" parameter.</p> <p>Options</p> <ul style="list-style-type: none"> › Standard: The GED behaves in accordance with the setting for the "Mode" parameter. › Off: The GED is dark when a validated person tries passing the passage in the wrong direction. › Red: The GED display a red cross when a validated person tries passing the passage in the wrong direction. <p>Factory setting</p> <ul style="list-style-type: none"> › Red

Description of menus and parameters

Operational view > Main menu > Settings > Signalling > GED no. 1 / GED no. 2	
Parameter	Description
Validation response (Signalling hold-open time end)	<p>Select the GED behaviour when the set hold-open time is below a certain value. The special signalling should encourage a person to move on.</p> <p>Options</p> <ul style="list-style-type: none"> › Off: No special signalling › Variant 1: If the hold-open time is less than 7 seconds, the GED will flash green at 1.7 Hz. › Variant 2: If the hold-open time is less than 7 seconds, the GED will flash green. The flashing frequency changes depending on the hold-open time: < 7 seconds 1 Hz, < 5 seconds 1.7 Hz, < 2 seconds 5 Hz <p>Factory setting</p> <ul style="list-style-type: none"> › Variant 2:
On intrusion	<p>Select the display pattern for the "On intrusion" event.</p> <p>Options</p> <p>↗ Page 55, section "Display pattern on the GED".</p> <p>Factory setting</p> <ul style="list-style-type: none"> › Pulse red 2.5 Hz
On wrong direction	<p>Select the display pattern for the "On wrong direction" event.</p> <p>Options</p> <p>↗ Page 55, section "Display pattern on the GED".</p> <p>Factory setting</p> <ul style="list-style-type: none"> › Toggle red/green 2.5 Hz
On tailgating	<p>Select the display pattern for the "On tailgating" event.</p> <p>Options</p> <p>↗ Page 55, section "Display pattern on the GED".</p> <p>Factory setting</p> <ul style="list-style-type: none"> › Double pulse short red
On emergency	<p>Select the display pattern for the "On emergency" event.</p> <p>Options</p> <p>↗ Page 55, section "Display pattern on the GED".</p> <p>Factory setting</p> <ul style="list-style-type: none"> › Double pulse short green
On error	<p>Select the display pattern for the "On error" event.</p> <p>Options</p> <p>↗ Page 55, section "Display pattern on the GED".</p> <p>Factory setting</p> <ul style="list-style-type: none"> › Pulse red 1 Hz

Table 30: GED no. 1 / GED no. 2

Display pattern on the GED

Option	Description
Off	No special display pattern for this state.
Dark	GED switched off
Red	GED shows a red cross.
Green	GED shows a green arrow.
Pulse red 1 Hz	GED flashes in red with a frequency of 1 Hz.
Pulse green 1 Hz	GED flashes in green with a frequency of 1 Hz.
Pulse red 2.5 Hz	GED flashes in red with a frequency of 2.5 Hz.
Pulse green 2.5 Hz	GED flashes in green with a frequency of 2.5 Hz.
Pulse red 5 Hz	GED flashes in red with a frequency of 5 Hz.
Pulse green 5 Hz	GED flashes in green with a frequency of 5 Hz.
Double pulse short red	GED flashes in red twice every second with a pulse of 100 ms.
Double pulse short green	GED flashes in green twice every second with a pulse of 100 ms.
Toggle red/green 1 Hz	GED toggles between red and green with a frequency of 1 Hz. Red and green are each displayed for 500 ms.
Toggle red/green 2.5 Hz	GED toggles between red and green with a frequency of 2.5 Hz. Red and green are each displayed for 200 ms.
Toggle red/green 5 Hz	GED toggles between red and green with a frequency of 5 Hz. Red and green are each displayed for 100 ms.

Table 31: Display pattern on the GED

6.2.7 Random check function

The MGCplus control unit is equipped with the "Random check function" option. This function allows random bag and identity control of persons.

If a hit was generated by the random check function and the next validation is blocked by the random check function, the following symbol appears on the display of the control unit: «».

For the random check function you can choose between "Counting" or "Random" modes. You activate the random check function via a permanent signal (+24 V DC) at the "Random check function" input. If the random check function has generated a hit, the pedestrian gate is not opened despite a valid opening pulse. A signal is emitted at the output with the "Random hit" function. You can connect a signal lamp or a siren to this output.

The passage remains blocked until the random hit / validation is confirmed with a 0 V pulse at the "Random check function" input.

Operational view > Main menu > Settings > Random check function	
Parameter	Description
Mode	<p>Set the function of the random check function.</p> <p>Options</p> <ul style="list-style-type: none"> › Inactive: The random check function is not in operation. › Counting: If the number of passages since activation has reached the set value for the "Hit range" parameter, a hit is reported and the passage is blocked. For example, if you set the value "100" for the "Hit range" parameter, a hit is generated every 100th passage. The hit is confirmed via the "Random check function" input function. After acknowledgement, the random check function counter restarts. › Random: You can set the random probability using the "Hit range" and "Count of hits" parameters. By activating the random check function, the set "Count of hits" is randomly generated, which must lie within the set "Hit range". For example, if you set the value "100" for the "Hit range" parameter and "10" for the "Count of hits" parameter, hits are generated randomly for 10 people out of 100. <p>Factory setting</p> <ul style="list-style-type: none"> › Inactive

Operational view > Main menu > Settings > Random check function	
Parameter	Description
Hit range	<p>The function depends on the selected mode.</p> <p>For the "Counting" mode, use this parameter to set the value at which a hit is to be generated.</p> <p>For the "Random" mode, set the number range in which the random hits must lie. For example, if you set the value to "100", the random hits must be in the range 1 to 100.</p> <p>IMPORTANT! The value for the "Count of hits" parameter can be a maximum of 40 % of the value for the "Hit range" parameter. If the value set for the "Count of hits" parameter is too high, the "Count of hits" parameter is automatically adjusted.</p> <p>Setting range</p> <ul style="list-style-type: none"> > 10 to 10000 <p>Factory setting</p> <ul style="list-style-type: none"> > 1000
Count of hits	<p>Set the number of hits to be generated in the set Count of hits.</p> <p>IMPORTANT! The value for the "Count of hits" parameter can be a maximum of 40 % of the value for the "Hit range" parameter. If the value set for the "Hit range" parameter is too high, the "Hit range" parameter is automatically adjusted.</p> <p>Setting range</p> <ul style="list-style-type: none"> > 1 to 1000 <p>Factory setting</p> <ul style="list-style-type: none"> > 10
Delete validation	<p>Use the "Delete validation" parameter to specify whether the validation is to be deleted automatically in the event of a random hit.</p> <p>Options</p> <ul style="list-style-type: none"> > Yes (Activated [X]) <ul style="list-style-type: none"> Select this option if you want the check to take place before the passage. The user leaves the area via a separate passage. > No (Inactive []) <ul style="list-style-type: none"> Select this option if you want the passage to take place when the hit is confirmed. In this case, the check is carried out after the passage. <p>Factory setting</p> <ul style="list-style-type: none"> > No (Inactive [])

Description of menus and parameters

Operational view > Main menu > Settings > Random check function	
Parameter	Description
Direction	<p>Select the passage direction for which the random hits are to be generated.</p> <p>Options</p> <ul style="list-style-type: none"> > Both: Random hits occur in both passage directions. With this option, validations are not deleted. > Direction 1: Random hits occur only in passage direction 1. > Direction 2: Random hits occur only in passage direction 2. <p>Factory setting</p> <ul style="list-style-type: none"> > Both

Table 32: Random check function

6.2.8 Home offset

This menu is available only for pedestrian gates with swing wings.

Operational view > Main menu > Settings > Home offset	
Parameter	Description
All wings	<p>You can correct or teach-in the "Closed" position for the wings.</p> <p>Use the "All wings" parameter to select the time to align the wings to the "Closed" position.</p> <p>The drives will be powered down and the timer is started. Move both wings to the exact "Closed" position and wait until the timer has expired. The new position is saved and the control unit automatically restarts.</p> <p>Options</p> <ul style="list-style-type: none"> > 5 s > 10 s > 20 s > 60 s <p>Factory setting</p> <ul style="list-style-type: none"> > 5 s
Current settings	<p>Shows the current settings for "Wing 1" and "Wing 2".</p> <p>Factory setting</p> <ul style="list-style-type: none"> > 90.00 (90°)

Table 33: Home offset

6.3 Menu "Inputs/Outputs"

6.3.1 Digital inputs 1-8

↗ Page 23, chapter 4.1.

6.3.2 Digital outputs 1-4 and relay outputs 1-6

↗ Page 26, chapter 4.2.

6.4 Menu "Information"

6.4.1 Operating mode

Operational view > Main menu > Information > Operating mode	
Parameter	Description
Current mode	Shows the current operating mode of the control unit.
Reason	Shows the inputs and why this current operating mode is active.
Target mode	

Table 34: Operating mode

6.4.2 People Counter

6.4.2.1 In direction 1

Operational view > Main menu > Information > People counter > In direction 1	
Parameter	Description
Passages total	Shows the number of all validated and non-validated passages in direction 1.
Valid. passages	Shows the number of all validated passages in direction 1.
Reverted	Shows the number of people who have entered and exited the pedestrian gate on one side.
Intrusion	Shows the number of unauthorized access attempts of the "Intrusion" type in direction 1.
Wrong direction	Shows the number of unauthorized access attempts of the "Wrong direction" type in direction 2.
Tailgating	Shows the number of unauthorized access attempts of the "Tailgating" type in direction 1.

Table 35: People counter – In direction 1

6.4.2.2 In direction 2

Operational view > Main menu > Information > People counter > In direction 2	
Parameter	Description
Passages total	Shows the number of all validated and non-validated passages in direction 2.
Valid. passages	Shows the number of all validated passages in direction 2.
Reverted	Shows the number of people who have entered and exited the pedestrian gate on one side.
Intrusion	Shows the number of unauthorized access attempts of the "Intrusion" type in direction 2.
Wrong direction	Shows the number of unauthorized access attempts of the "Wrong direction" type in direction 1.
Tailgating	Shows the number of unauthorized access attempts of the "Tailgating" type in direction 2.

Table 36: People counter – In direction 2

6.4.3 Light barriers (PE beams)

Operational view > Main menu > Information > Light barriers (PE beams)	
Parameter	Description
Occupied	Shows the light barriers (PE beams) that are currently occupied.
Warning	<p>Shows the light barriers (PE beams) that are currently occupied for too long. The warning time is adjusted using the "Warning light barriers (PE beams)" parameter. ↗ Page 52, "Warning light barriers (Parameter)".</p> <p>If one of the light barriers (PE beams) is occupied for longer than the set time, the output "Warning light barriers (PE beam)" is set. ↗ Page 28, "Warning light barriers (Output)".</p> <p>Prerequisites</p> <ul style="list-style-type: none"> › "Warning light barriers (PE beams)" parameter: > 0 s

Table 37: Light barriers (PE beams)

6.5 Menu "System"

Operational view > Main menu > System	
Parameter	Description
Reboot	<p>Reboot the control unit.</p> <p>A reboot may be required after parameter changes.</p> <ul style="list-style-type: none"> > Yes > No <p>Factory setting</p> <ul style="list-style-type: none"> > No
Language	Changing menu language. ↗ Page 29, chapter 5.1.
Control unit	Shows information about the hardware (Hardware info) and the firmware.
IP settings	<p>The parameter "Change IP method" allows you to choose between static IP or DHCP. A change is only required for remote support or advanced applications.</p> <p>Additionally, this menu shows the current IP settings: Method, address, mask, gateway and MAC.</p>
Remote support	<p>Select option for remote access / remote support.</p> <p>Prerequisites</p> <p>The requirement for remote access / remote support are as follows:</p> <ul style="list-style-type: none"> > The control unit is connected via LAN. > Internet access is available. > All IP settings are configured correctly. <p>Via Magnetic, you can purchase additional hardware to connect the control unit to the Internet without connecting it to your LAN.</p> <p>Options</p> <ul style="list-style-type: none"> > No remote support: The control unit does not send support information to Magnetic. The remote access is deactivated. > Send emails only: The control unit does not mail any application protocols to Magnetic. > Remote access only: The control unit establishes an SSH tunnel (Secure Shell) to Magnetic, enabling remote access for technical support. > Full remote access: Activates all available remote support functions. <p>Factory setting</p> <ul style="list-style-type: none"> > No remote support
USB drive	<p>For advanced logging and troubleshooting purposes, you can connect a USB stick to the control unit.</p> <p>This menu shows the status, the label and the free capacity. Additionally, you can remove the USB stick safely.</p>
CAN bus	Shows information about the internal system bus.
Restore settings	↗ Page 62, chapter 6.5.1.

Table 38: System

6.5.1 Restore settings



IMPORTANT!

The parameters of the control unit are stored in the three memory areas "FW settings", "Factory settings" and "User settings".

The FW settings are identical to the FW settings in these operating instructions. The FW settings cannot be modified.

However, the factory setting can be assigned factory- or product-specific settings.

The user settings are the operating parameters.

Operational view > Main menu > System > Restore settings	
Parameter	Description
Restore settings	<p>Select settings to be restored.</p> <p>Options</p> <ul style="list-style-type: none"> › No action: No settings are restored. › Restore IP settings: All settings in the IP Settings menu are restored to default settings. › To factory setting: The stored parameters in the memory area "Factory settings" are adopted as operating settings. › To FW defaults: The stored parameters in the memory area "FW settings" are adopted as operating settings. <p>Factory setting</p> <ul style="list-style-type: none"> › No action

Table 39: Restore settings

6.6 Menu "Service"

Operational view > Main menu > Service	
Parameter	Description
Cycle counter	Shows the current number of cycles for "Wing 1" and "Wing 2". The counter is incremented by one when the wings are opened. The wings must first be closed for the counter to increment again with the next opening.
Operating time	Shows the current operating time. The operating time is the time during which the control unit is supplied with electrical power.
Date / time	Shows the internal date and time of the control unit.

Operational view > Main menu > Service	
Parameter	Description
Main menu password	<p>Activate and deactivate password protection for the main menu</p> <p>To activate a change of the settings, either call the operational view or switch the voltage supply on or off.</p> <p>Options</p> <ul style="list-style-type: none"> › Inactive: You can change the main menu without entering a password. › Active: You can change the main menu only after entering a password. The password is identical with the one for the menu "Service". <p>Factory setting</p> <ul style="list-style-type: none"> › Inactive
Save factory settings	<p>Save current operating parameters as "factory settings". The service password is required for this action.</p>

Table 40: Service

7 Corrective action

7.1 Safety in troubleshooting



Qualification of personnel

- › Technician
- › Magnetic MHTM™ FlowMotion® service expert

Personal protective equipment

Wear the following personal protective equipment:

- › Work clothes
- › Protective gloves
- › Safety shoes.

 WARNING	
	<p>Inappropriate troubleshooting!</p> <p>Inappropriate troubleshooting can cause severe injuries.</p> <ul style="list-style-type: none">› Observe possible movements of the blocking element. Defective control may lead to inadvertent movement of the blocking element.› In case of damaged components, take the pedestrian gate out of operation.› Use only original spare parts.› After completion of troubleshooting, ensure that all covers are correctly mounted.

This chapter describes possible causes of malfunctions and troubleshooting tasks.

Contact your dealer or customer service if you are unable to rectify the malfunctions due to the following descriptions.

7.2 Malfunctions pedestrian gate

Malfunction: Display is difficult or impossible to read.

Possible cause	Corrective action	Removal by
Display contact set too light or dark.	Correct display contact. ↗ Page 38, chapter 5.6.	Technician

Malfunction: The blocking element does not open.

Possible cause	Corrective action	Removal by
Power supply is not connected	<ul style="list-style-type: none"> › Switch on power supply. › Check power supply. 	Technician
Error present. The corresponding error message is displayed.	Depending on error message, check components, wiring, etc.	MHTM™ FlowMotion® service expert
Power supply is present. Control unit display does not light up.	Control unit defective. Replace the control unit.	MHTM™ FlowMotion® service expert
Locking signal present.	Remove locking signal.	MHTM™ FlowMotion® service expert

Malfunction: Display only shows "Internal Error".

Possible cause	Corrective action	Removal by
Short circuit in CAN system bus	<ul style="list-style-type: none"> › Check all components connected to the CAN system bus. To do so, remove all connected components and reconnect them one after another. › Check the terminating resistances. 	MHTM™ FlowMotion® service expert

7.3 Event, warning and error messages in the display

The control unit differentiates between events, warnings and errors. The corresponding message is displayed.

Event messages "INFO"

Event messages inform about events. The pedestrian gate continues to operate normally. Event messages do not influence the outputs of the control unit.

Warning messages "WARNING"

Faults that could be reset by the control unit are displayed as warnings. Operation of the pedestrian gate is not or only briefly impaired.

If the function "Warning" has been chosen for an output, this output is deactivated at pending warnings (fail safe).

Error messages "ERROR"

Faults that cannot be reset by the control unit are displayed as errors. The pedestrian gate is put out of service.

If the function "Error" has been chosen for an output, this output is deactivated at pending errors (fail safe).

The fault must be rectified and a reset carried out by a MHTM™ FlowMotion® service expert so that the pedestrian gate can be put back into operation.

↗ For the required qualification of the MHTM™ FlowMotion® service expert see ↗ Page 10, chapter 1.3.1.



IMPORTANT!

With some messages, the control unit tries to reset the cause of the message. If the attempt was successful, the message is displayed as WARNING. If the attempt failed, the message is displayed as ERROR.

7.3.1 Event, warning and error messages – Logic control (Control unit)

"[nn]" is a placeholder for the number of the component that may be causing an error.

Number	Designation	Possible cause	Corrective action
ERROR 0x10001000	Hardware revision could not be detected	MPM01 extension module defective	› Contact service.
ERROR 0x11001000	SD card error	MPM01 extension module defective	› Contact service.
ERROR 0x20001000	CANopen system bus could not be started	A defective IO extension or motor control is connected to the system bus.	› Check the CAN bus wiring. › Check the settings of the terminating resistance.
ERROR 0x30013003 0x30023004	Motor for wing no. 1 / 2 not available	Incorrect motor address setting or defective motor electronics	› Check for correct motor address setting. › Check the CAN bus wiring. › Check the settings of the terminating resistance. › Contact service.
ERROR 0x3001F003 0x3002F004	Information on motor no. 1 / 2 could not be read	CAN system bus faulty	› Check the CAN bus wiring. › Check the settings of the terminating resistance. › Contact service.
ERROR 0x30011003 0x30021004	Internal referencing error on motor for wing no. 1 / 2	Gear installed in motor defective	› Change motor unit.
ERROR 0x3001F100 0x3002F100	Wrong motor type for wing no. 1 / 2	Wrong motor type used	› Change motor unit.
ERROR 0x4001F000 0x4002F000	The minimum required span of wing 1 / 2 was not reached during homing	Wing 1 / 2 locked during commissioning or wing mechanics defective	› Remove obstacles that block the movement of the wing during commissioning. › Switch off the pedestrian gate and check the wing for ease of movement.

Corrective action

Number	Designation	Possible cause	Corrective action
ERROR 0x50nn1048 0x50nn1049 0x50nn104A 0x50nn104B 0x50nn104C	Error during initialisation of the IM16 input extension in the MGC slot number [nn]	Input extension in slot [nn] not mounted mechanically correct. E.g. input extension is tilted or wrong slot was selected.	<ul style="list-style-type: none"> › Check slot number and mounting of the IM16 input extension. › Check the settings of the CAN bus terminating resistance. › Replace the IM16 input extension. › Contact service.
ERROR 0x50nn3048 0x50nn3049 0x50nn304A 0x50nn304B 0x50nn304C	Error during communication with an IM16 input extension installed in MGC slot number [nn]	Defective IO extension or system bus disturbed during runtime	<ul style="list-style-type: none"> › Check slot number and mounting of the IM16 input extension. › Check CAN bus wiring for loose plugs. › Check the settings of the CAN bus terminating resistance. › Replace the IM16 input extension. › Contact service.
ERROR 0x6001F000	Safety controller error	Internal motor control defective	<ul style="list-style-type: none"> › Contact service.

Table 41: Event, warning and error messages – logic control (Control unit)

7.4 Perform reset

If you use one of the following options, the control unit will perform a reset:

- › Switch of power supply and switch it on again after 10 s.
- › Press the two middle operating buttons on the control unit display for 5 s.
- › Using the parameter "Reboot" (menu path: Operational view > Main menu > System > "Reboot")
- › Set the input with the "Reset" function.

NOTICE



Fast restart!

Switching the pedestrian gate on again too fast can lead to damage to the device!

- › Wait for at least 10 seconds after switching off the pedestrian gate before you switch the mains power on again.

8 Menu setup

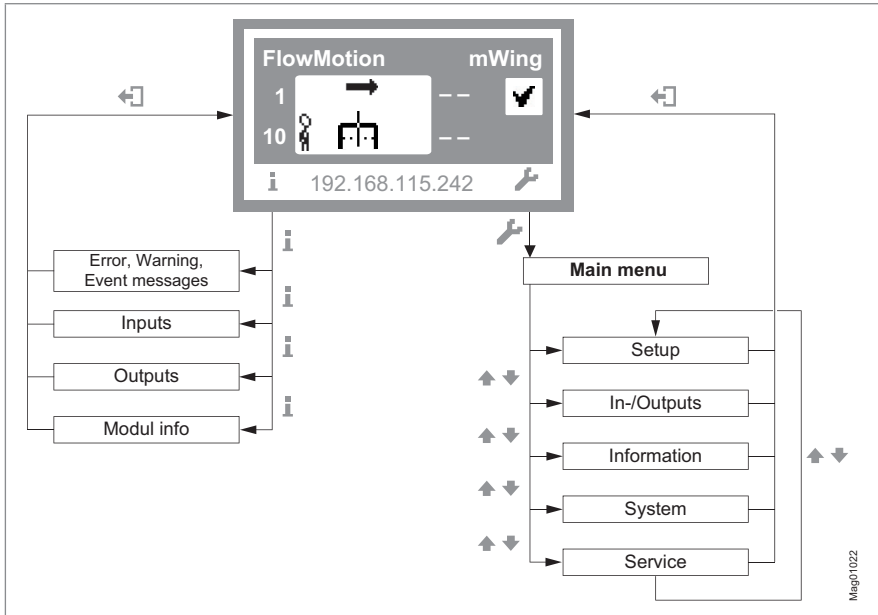
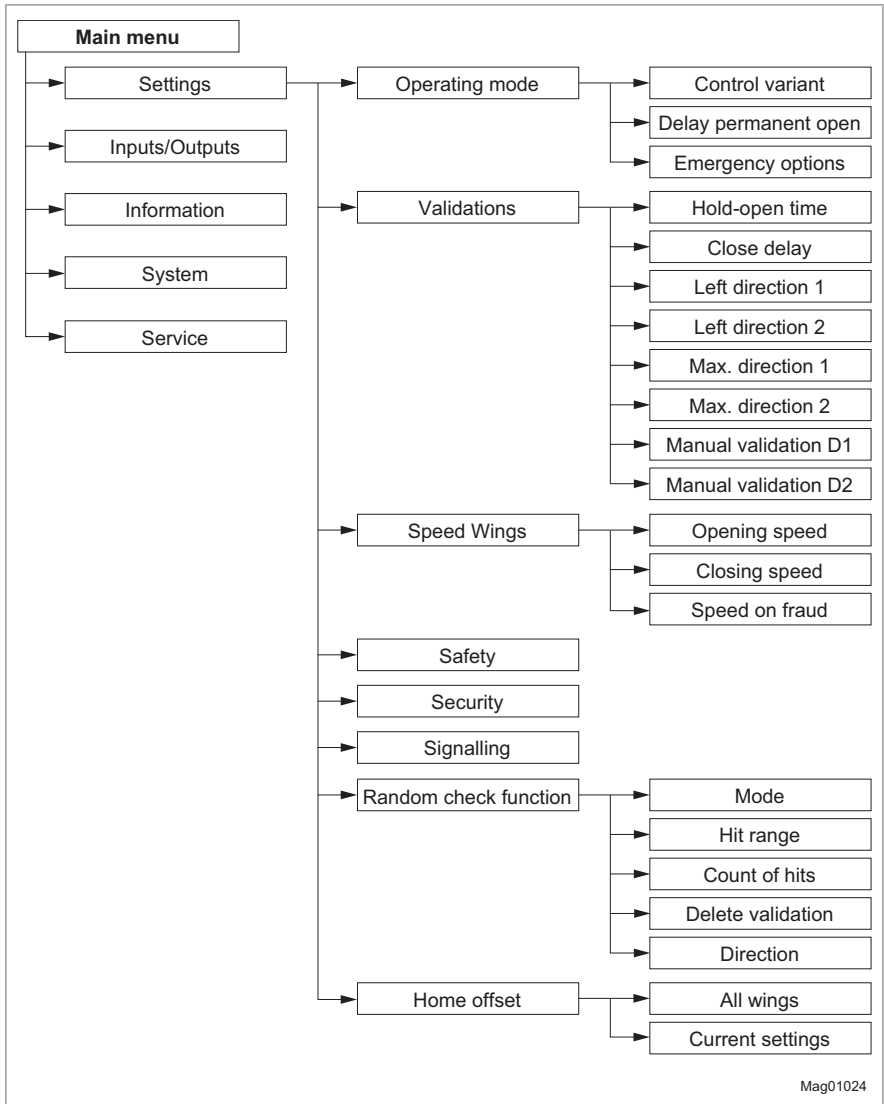

Fig. 18: Menu "Information" and "Main menu"



Mag01024

Fig. 19: "Settings" menu
 For the "Safety", "Security" and "Signalling" submenus, see the following figures.

Menu setup

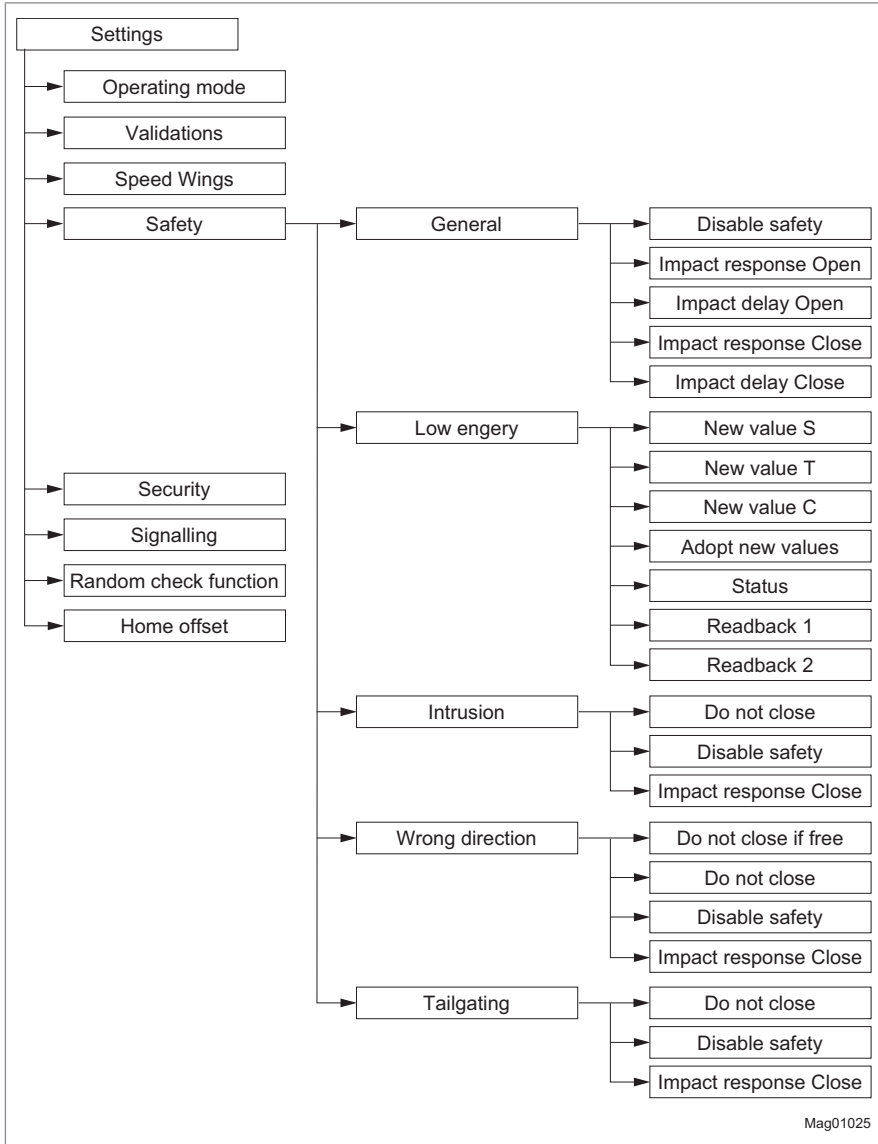

Fig. 20: "Settings" menu – "Safety"

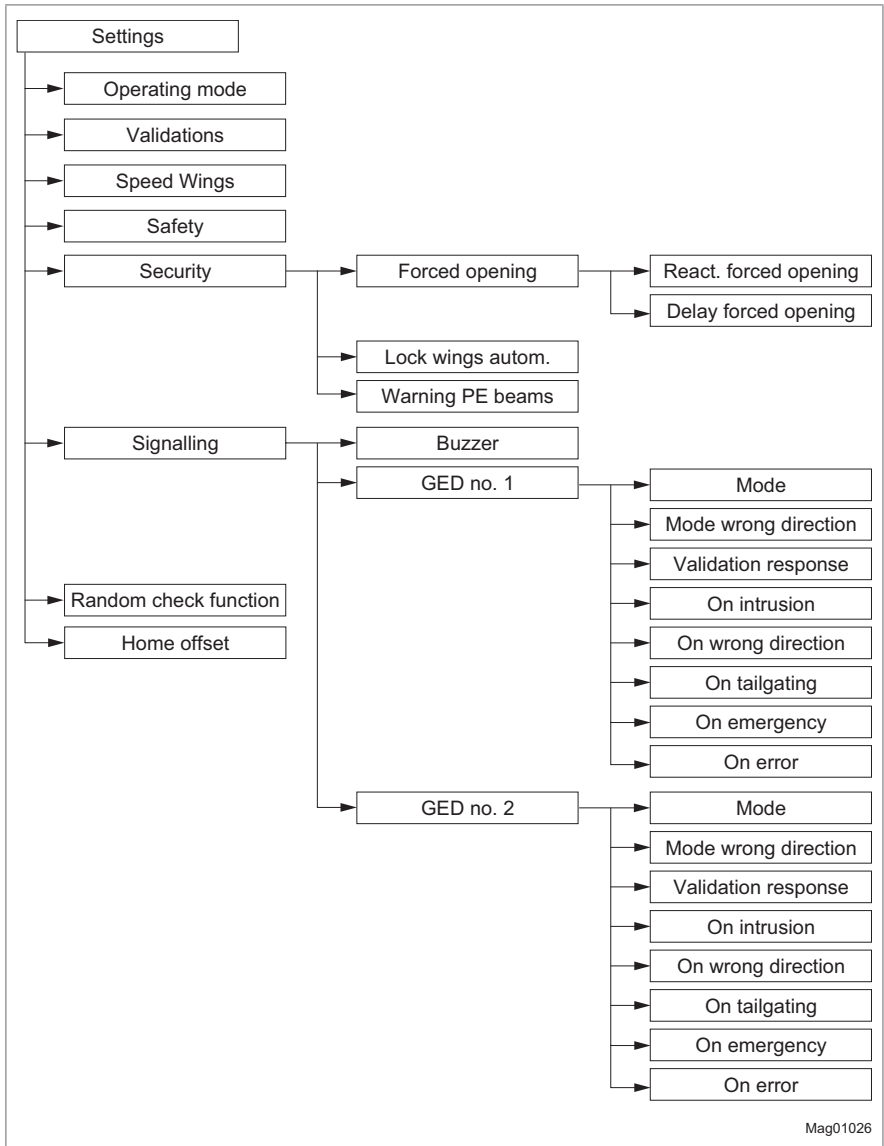

Fig. 21: "Settings" menu – "Security" and "Signalling"

Menu setup

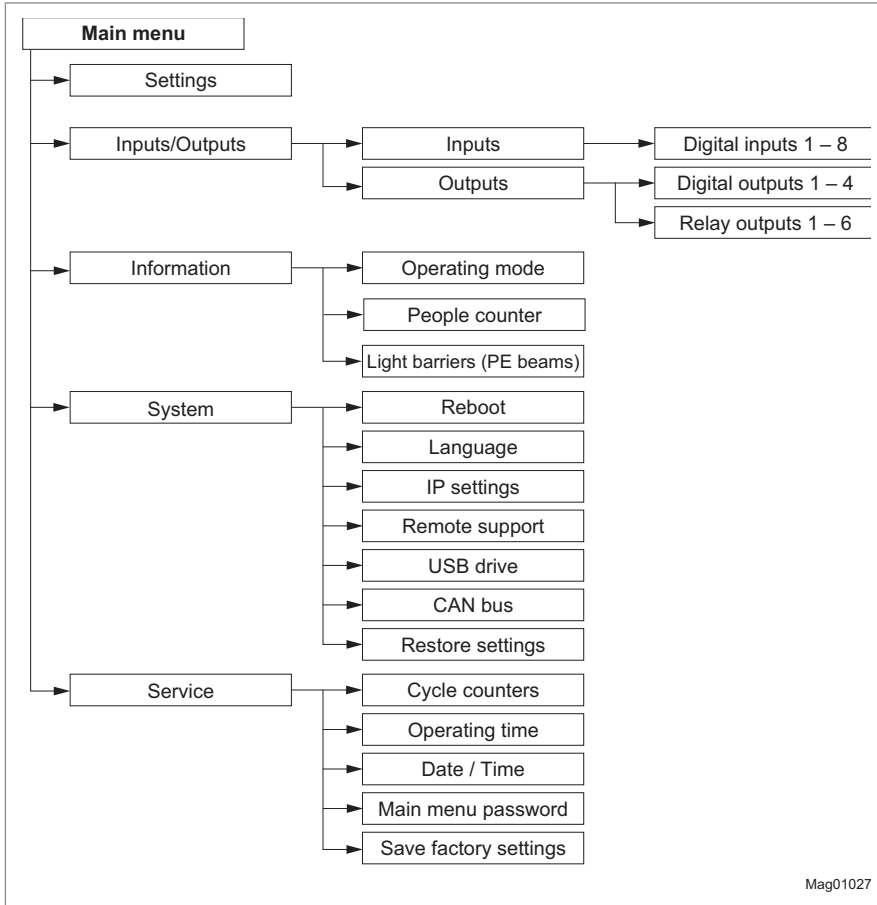

Fig. 22: "Inputs/Outputs", "Information", "System" and "Service" menus
For the "Information" submenus, see the following figure.

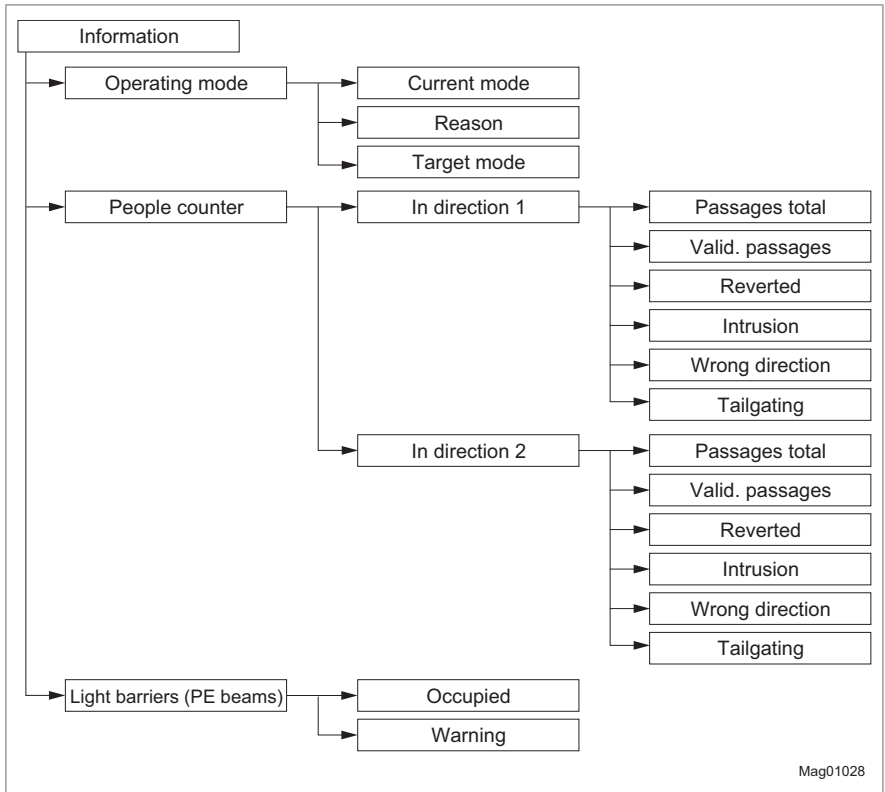

Fig. 23: "Information" menu – "Operating mode", "People counter" and "Light barriers (PE beams)"

Index

Symbole

Emergency open	24
Error.....	26

A

Adopt new values	48
All wings	58

B

Boot-up.....	16
Buzzer	
Menu	52
Output	27
Buzzer (static)	
Output	27

C

CAN bus	61
Changing menu language	29
Closed D1/Contr. D2	
Description	13
Input function.....	25
Closed D1/Contr. D2 OM	
Input function.....	25
Closed D1/Free D2	
Description	14
Closed D2/Free D2	
Input function.....	25
Closed D2/Free D2 OM	
Input function.....	25
Closing delay.....	43
Closing speed	44
Contr.	9
Contr. D1/Closed D2	
Description	13
Input function.....	25
Contr. D1/Closed D2 OM	
Input function.....	25
Contr. D1+D2	
Description	13
Input function.....	25
Contr. D1+D2 OM	25

Contr. D1/Free D2	
Description	14
Input function.....	25
Contr. D1/Free D2 OM	
Input function.....	25
Control direction 1	
Function.....	17
Input function.....	24
Control direction 2	
Function.....	17
Input function.....	24
Control open mode	24
Control unit elements.....	34
Control variant.....	41
Function.....	17
Variant 1, function	19
Variant 2, function	21
Corrective action	64
Counting	56
Count of hits	57
Critical error	16
Current settings.....	58
Cycle counter.....	62

D

D1	9
D2	9
Date / time	62
Delay.....	9
Delay forced opening	51
Delay permanent open.....	41
Function.....	17
Delete validation	57
Digital outputs.....	23, 26
Direction	58
Direction 1. See Passage direction 1	
Direction 2. See Passage direction 2	
Disable safety	45
Intrusion	48
Tailgating.....	50
Wrong direction.....	49
Display contrast	38
Display control unit	35
Symbols	36

Index

Do not close		Hit range.....	57
Intrusion	48	Hold-open time	42
Tailgating.....	50	Home offset.....	58
Wrong direction.....	49		
Do not close if free	49		
E		I	
Emergency mode.....	16	Impact delay Close	
Emergency open.....	24	General	46
Emergency options.....	42	Impact delay Open	
Entering password.....	33	General	45
Error	26	Impact response Close	
Error messages	40, 66	General	46
Event messages	40, 66	Intrusion	49
		Tailgating.....	50
		Wrong direction.....	50
		Impact response Open	
F		General	45
Forced opening.....	51	In direction 1	59
Fraud	27	In direction 2	60
Fraud direction 1	27	Information	
Fraud direction 2	27	Menu	59
Free D1/Closed D2		Operating display menu.....	40
Description	13	Inputs	23, 40
Input function	25	Factory setting.....	23
Free D1/Closed D2 OM		Intrusion.....	12, 27
Input function.....	25	In direction 1.....	59
Free D1/Contr. D2		In direction 2.....	60
Description	14	Safety.....	48
Input function	25	Intrusion D1.....	27
Free D1/Contr. D2 OM		Intrusion D2.....	27
Input function	25	IP settings	61
Free D1+D2			
Description	14	L	
Input function.....	25	Language	61
Free D1+D2 OM		Left direction 1	43
Input function.....	25	Left direction 2	43
		Light barriers (PE beams).....	40
G		Lock wings autom.....	51
GED green left	28	Low energy	47
GED green right	28		
GED no. 1.....	53	M	
GED no. 2.....	53	Magnetic MHTM™ FlowMotion® service	
GED red left	28	expert	10
GED red right.....	28	Main menu password.....	63
		Malfunctions	
H		Control unit.....	67
Hit obstacle.....	28	Pedestrian gate	65

Manual validation D1	43	Passages total	
Manual validation D2	44	In direction 1.....	59
Max. direction 1	43	In direction 2.....	60
Max. direction 2	43	PE beams	12, 60
Menu		People counter	59
Information.....	40	Perform homing	16
Settings.....	41		
Menu setup	70	Q	
Mode	53	Qualification	
Mode (random check function).....	56	Personnel	10
Mode wrong direction.....	53		
N		R	
New value C.....	48	Random	56
New value S	48	Random check function	
New value T	48	Input function	25
No access.....	13, 25	Menu	56
Notices		Random hit.....	26
Presentation	9	React. forced opening	51
O		Readback 1	48
Occupied		Readback 2	48
Light barriers.....	60	Reboot.....	61
OM.....	9. See Open mode	Relay outputs.....	23, 26
On emergency	54	Remote support	61
On error.....	54	Reset.....	69
On tailgating	54	Input function	24
On wrong direction	54	Restore settings.....	61, 62
Opening speed	44	Reverted	
Open mode		In direction 1.....	59
Setting.....	15	In direction 2.....	60
Operating modes		RGB illumination off	25
Description	13	S	
Special.....	16	Safety.....	45, 51
Operating time	62	Save factory settings.....	63
Operational view	35	Service	
Outputs	23, 40	Menu	62
Factory setting	26	Settings	
P		Menu	41
Parameterise	38	Side 1.....	12
Passage clear	27	Side 2.....	12
Passage clear D1.....	27	Signalling	52
Passage clear D2.....	27	Speed on fraud	44
Passage direction 1.....	12	Speed Wings.....	44
Passage direction 2.....	12	Status	
		Low energy	48

Index

System		Wings closed	26
Menu	61	Wings locked	26
T		Wings opened	26
Tailgating	12, 28	Wings opened D1	26
In direction 1.....	59	Wings opened D2	26
In direction 2.....	60	Wrong direction.....	12, 27
Safety.....	50	In direction 1.....	59
Tailgating D1	28	In direction 2.....	60
Tailgating D2	28	Safety.....	49
Target groups.....	10	Wrong direction D1	27
		Wrong direction D2	27
U			
Unauthorised access attempts.....	12		
Intrusion	12		
Tailgating.....	12		
Wrong direction.....	12		
USB drive	61		
V			
Validation direction 1	24		
Validation direction 2	24		
Validation response.....	54		
Validations	42		
Valid. passage			
In direction 1.....	59		
In direction 2.....	60		
Val. pers.	9		
Val. pers. passed.....	9, 27		
Val. pers. passed D1.....	27		
Val. pers. passed D2.....	27		
Val. pers. present.....	27		
Val. pers. present D1	27		
Val. pers. present D2	27		
W			
Wait for homing	16		
Warning			
Light barriers.....	60		
Warning light barriers (PE beams)			
Output	28		
Parameter	52		
Warning messages.....	40, 66		
Warning notes			
Presentation	8		
Wing forced open.....	28		

MAGNETIC AUTOCONTROL GMBH

Grienmatt 20
D-79650 Schopfheim
Germany

Sales partner

Phone +49 7622 695 5
Fax +49 7622 695 802
info@magnetic-germany.com
www.magnetic-access.com



F10044452

Doc.ID: 5817,0033EN
Version 00